

Technical Manual



MDT Switch Actuator with active power measurement

AZI-0316.01 – Schaltaktor mit Wirkleistungszähler, 3-fach

AZI-0616.01 – Schaltaktor mit Wirkleistungszähler, 6-fach

1 Content

1 Content.....	2
2 Overview.....	4
2.1 Overview devices.....	4
2.2 Usage & Areas of Application.....	4
2.3 Structure & Handling.....	5
2.4 Functions.....	6
2.5 Settings at the ETS-Software.....	7
2.6 Starting up.....	7
3 Communication objects.....	8
3.1 Summary and Usage.....	8
3.2 Default settings of the communication objects.....	17
4 Parameter – Switch Channel.....	20
4.1 Identical parameter.....	20
4.1.1 Relay operating mode.....	20
4.1.2 Central function.....	21
4.1.3 Behavior at block/unblock.....	21
4.2 Switching output.....	23
4.2.1 Overview.....	23
4.2.2 On-/Off-delay.....	25
4.2.3 Logical functions.....	26
4.2.4 Scene function.....	28
4.3 Staircase.....	33
4.3.1 Overview.....	33
4.3.2 Staircase time.....	35
4.3.3 Prewarning und Warning.....	36
4.3.4 Manual switch off.....	37
4.3.5 Extend staircase time.....	37
5 Parameter - Measurement.....	38
5.1 Active power measurement.....	38
5.1.1 Advanced power output.....	41
5.2 Current measurement.....	42
5.3 Voltage measurement.....	44
5.4 Meter.....	46
5.4.1 Events.....	48

5.5 Operating hours.....	49
5.5.1 Operating hours counter	49
4.7.2 Reverse counter	50
6 Central functions & Total functions	52
6.1 General settings.....	52
6.2 Settings for cost calculation	53
6.3 Total active power.....	57
6.4 Total current.....	60
6.5 Total energy meter and cost counter.....	63
6.5.1 Events	65
7 Index	66
7.1 List of figures	66
7.2 List of tables.....	67
8 Attachment.....	68
8.1 Statutory requirements.....	68
8.2 Routine disposal	68
8.3 Assemblage.....	68
8.4 Datasheet	68

2 Overview

2.1 Overview devices

The manual refers to the following devices:

- **AZI-0316.01** Switch actuator with active power measurement, 3-fold
 - Switching and Staircase functions, integrated True RMS Current measurement, active power measurement by current and voltage measurement, Logic functions
- **AZI-0616.01** Switch actuator with active power measurement, 6-fold
 - Switching and Staircase functions, integrated True RMS Current measurement, active power measurement by current and voltage measurement, Logic functions

2.2 Usage & Areas of Application

The switch actuator with active power measurement can be performed while electrical parameters are measured at the same time. The switching actuator with active power measurement contains of extended switching functions with on-/off-Delay, locking functions, scene functions and staircase functions. Furthermore two logic objects can be used per channel with And-/Or-connections.

Via the integrated True RMS Measurement, the energy consumption of connected loads can be watched. The switching actuator with active power measurement contains of an integrated current and voltage measurement, so the real active power can be calculated. So the ohmic part of a load can be evaluated and the reactive power can be evaluated separately. Also information about the power factor, $\cos \phi$, can be evaluated.

Furthermore switching functions at exceeding/not exceeding of current, voltage or power values can be performed.

Via energy meter functions, energy consumption and costs of time periods can be monitored via intermediate and main meter.

Operating hours counter and total current/total active power meter over all channels complete the functions of the switching actuator with active power measurement.

2.3 Structure & Handling

The following figure shows the design of the 3-fold model:

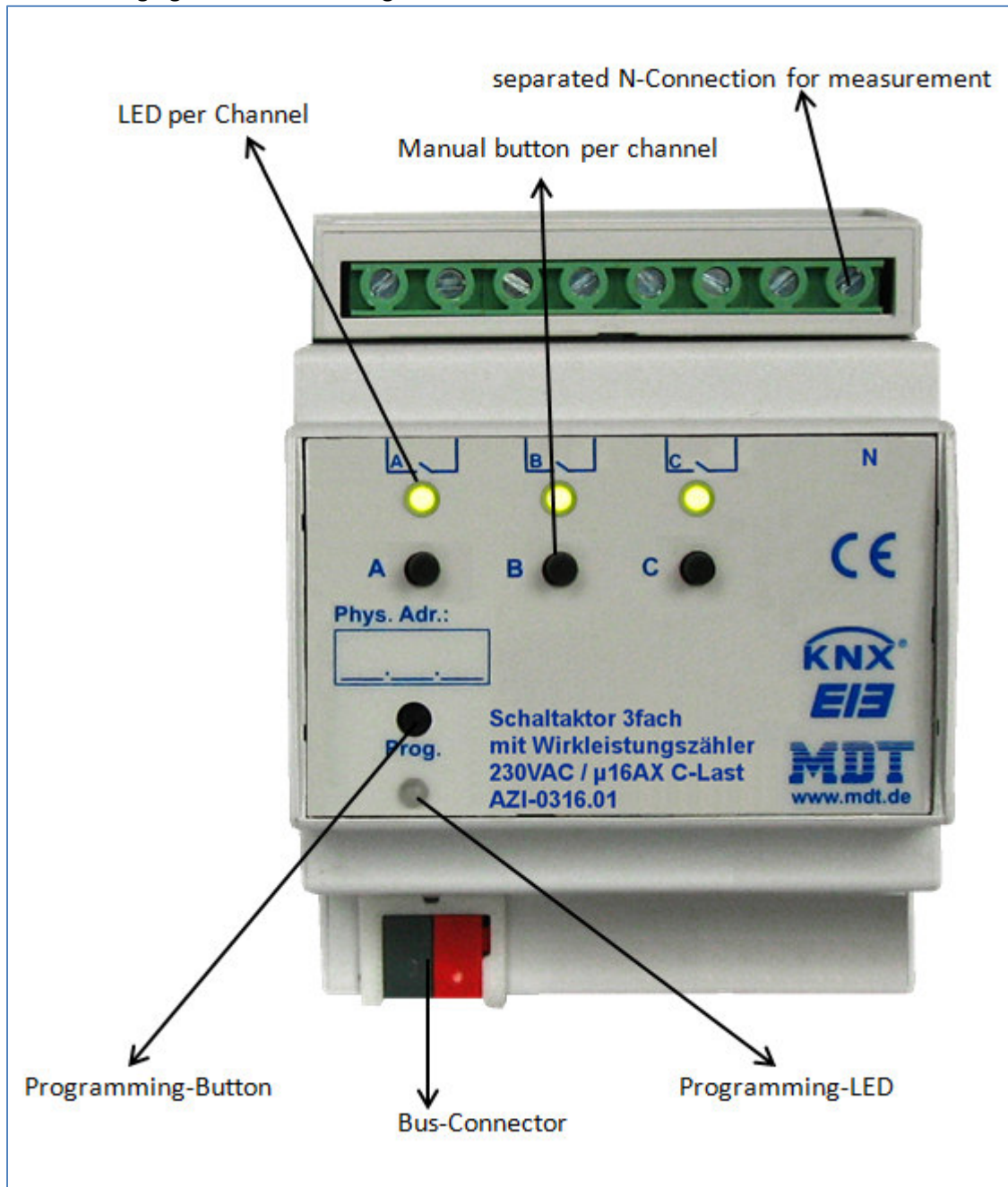

Figure 1: Overview Hardware

Every channel can be switched via the manual button on/off, when the channel and the manual control are activated in the parameter.

For the measurement, the N-Connector must be connected.

2.4 Functions

Every channel can be selected as one of these 3 states:

- **not active**
The channel has no function. So there are no communication objects for this channel shown.
- **Switch**
If the channel is chosen as switch, there will be different parameterization options for configuring the switching process.
- **Staircase**
Now, the channel can become a staircase light function. This function causes an automatic switch off of the channel after an adjusted time.

At the RF socket with active power measurement, the following menus are also available:

- **Active power measurement**
The active power measurement can send the current power of the connected load and in accordance to the value, specific function, such as Send messages and / or switch the output off, can be triggered.
Furthermore additional parameters like reactive power, apparent power and power factor $\cos \Phi$ can be evaluated.
- **Current measurement**
The current measurement can send the measured current of the connected load and in accordance to the value, specific function, such as Send messages and / or switch the output off, can be triggered.
- **Voltage measurement**
The voltage measurement can send the measured current of the connected load and in accordance to the value, specific function, such as Send messages and / or switch the output off, can be triggered.
- **Meter**
2 counters, main and sub meters, are available. With these various power measurements for daily / weekly / monthly or annual values can be realized.
- **Operating hours counter**
The operating hours counter can count active hours a connected device. Measuring conditions and type of counter (forward or reverse counter) can be set.

Furthermore settings for the total active power, total current or total energy meter and cost counter of the whole device are available.

2.5 Settings at the ETS-Software

Selection at the product database:

Manufacturer: MDT Technologies

Product family: Actuator

Product type: Switch Actuators

Medium Type: Twisted Pair

Product name: addicted to the used type, e.g.: AZI-0616.01

Order number: addicted to the used type, e.g.: AZI-0616.01

2.6 Starting up

After wiring the allocation of the physical address and the parameterization of every channel follow:

- (1) Connect the interface with the bus, e.g. MDT USB interface
- (2) Connect bus power
- (3) Connect main power
- (4) Press the programming button at the device (red programming LED lights)
- (5) Loading of the physical address out of the ETS-Software by using the interface (red LED goes out, as well this process was completed successful)
- (6) Loading of the application, with requested parameterization
- (7) If the device is enabled you can test the requested functions (also possible by using the ETS-Software)

3 Communication objects

3.1 Summary and Usage

Nr.	Name	Object function	Data type	Direction	Info	Usage	Tip
Switch Channel:							
0	Channel A	Switch on/off	DPT 1.001	receive	Actuator reacts to Incoming-telegram	Push buttons, Visu... for manual control	Communication object is shown at the operating mode „switch“ and controls the channel On/Off , which is normally connected to all control keys. (= Main function at switch)
1	Channel A	Staircase	DPT 1.001	receive	Actuator reacts to Incoming-telegram	Push buttons, Visu... for manual control	Communication object is shown at the operating mode „switch“ and controls the channel On/Off , which is normally connected to all control keys. The channel switches off again after adjusted time is expired. (= Main function at staircase)
2	Channel A	Block	DPT 1.003	receive	Actuator reacts to Incoming-telegram	Push buttons, Visu... for manual control	Communication object is only shown after activation of the blocking object. Object blocks the function of this channel. (= Additional function)
3	Channel A	Scene	DPT 18.001	receive	Actuator reacts to Incoming-telegram	Push buttons, Visu... for manual control	Communication object appears only after activating scenes . For calling of saved scenes, which are saved in the actuator. (= Additional function)

Technical Manual Switch Actuator – active power meas.

4	Channel A	Status	DPT 1.001	sending	Actuator sends current state	For display on Visu, Tableau, and Display Connection to Push button object „Value for toggle“	Communication object operates as status indication and can be used for visualization... Must be connected to the object “value for toggle” of the controlling push button for sending its current state to the push button.
5	Channel A	Logic 1	DPT 1.002	receive	Actuator reacts to Incoming-telegram	external switching, state object of other devices	Channel switches only On, if the logic function of activated objects and switching onbject (Nr. 85) is true. Only available for switching output.
6	Channel A	Logic 2	DPT 1.002	receive	Actuator reacts to Incoming-telegram	external switching, state object of other devices	Channel switches only On, if the logic function of activated objects and switching onbject (Nr. 85) is true. Only available for switching output.

Table 1: Communication objects switching output

Technical Manual Switch Actuator – active power meas.

The following objects are only for the device RF-AZK1St.01 available:

Nr.	Name	Object function	Data type	Direction	Info	Usage	Tip
Objects for the measurement:							
7	Active power meter	Active power	DPT 9.024/ DPT 14.056	send	Socket sends the current power of the connected load	Visu, Diagnostic, Recording	Communication object is shown at activated power measurement
8	Active power meter	Current value	DPT 7.012/ DPT 9.021/ DPT 14.019	send	Socket sends the current of the connected load	Visu, Diagnostic, Recording	Communication object is shown at activated current measurement
9	Active power meter	Voltage value	DPT 14.027	send	Socket sends the current voltage at the connected load	Visu, Diagnostic, Recording	Communication object is shown at activated voltage measurement
10	Advance power measurement	Apparent power in W/ Apparent power in kW/ Reactive power in W/ Reactive power in kW/ Power factor cos phi	DPT 14.056/ DPT 9.024/ DPT 14.056/ DPT 9.024/ DPT 14.057	send	Actuator sends advanced power measurement data	Visu, Diagnostic, Recording	Communication object is shown when the advanced power measurement is enabled in the menu "active power measurement"; DPT and type of measurement according to parameterization
11	Active power meter	Exceeding of load	DPT 1.001	send	Actuator sends exceeding of load	Visu, Diagnostic, Actuator	Communication object is shown at activated active power measurement and load monitoring
12	Active power meter	Falling below of load	DPT 1.001	send	Actuator sends falling below load	Visu, Diagnostic, Actuator	Communication object is shown at activated active power measurement and load monitoring

Technical Manual Switch Actuator – active power meas.

13	Active power meter	Exceedance of current	DPT 1.001	send	Actuator sends exceeding of current	Visu, Diagnostic, Actuator	Communication object is shown at activated current measurement and current monitoring
14	Active power meter	Lower deviation of current	DPT 1.001	send	Actuator sends falling below current	Visu, Diagnostic, Actuator	Communication object is shown at activated current measurement and current monitoring
15	Active power meter	Exceedance of voltage	DPT 1.001	send	Actuator sends exceeding of voltage	Visu, Diagnostic, Actuator	Communication object is shown at activated voltage measurement and voltage monitoring
16	Active power meter	Lower deviation of voltage	DPT 1.001	send	Actuator sends falling below voltage	Visu, Diagnostic, Actuator	Communication object is shown at activated voltage measurement and voltage monitoring
17	Intermediate meter	Active energy Wh/kwh	DPT 13.010/ DPT 13.013	send	Actuator sends added power	Visu, Diagnostic...	Communication object is shown at activated intermediate meter
18	Intermediate meter	Display costs in Euro	none, 4 Byte-Wert	send	Actuator sends added costs	Visu, Diagnostic...	Communication object is shown at activated intermediate meter
19	Intermediate meter	Meter reading for day	DPT 13.010/ DPT 13.013	send	Actuator sends added power in day mode	Visu, Diagnostic...	Communication object is shown at activated intermediate meter
20	Intermediate meter	Meter reading for night	DPT 13.010/ DPT 13.013	send	Actuator sends added power in night mode	Visu, Diagnostic...	Communication object is shown at activated intermediate meter
21	Intermediate meter	Reset	DPT 1.001	receive	Resetting the intermediate meter	Push Button, Visu...	Communication object is shown at activated intermediate meter

Technical Manual Switch Actuator – active power meas.

22	Main meter	Active energy Wh/kwh	DPT 13.010/ DPT 13.013	send	Actuator sends added power	Visu, Diagnostic...	Communication object is shown at activated main meter
23	Main meter	Display costs in Euro	none, 4 Byte-Wert	send	Actuator sends added costs	Visu, Diagnostic...	Communication object is shown at activated main meter
24	Main meter	Meter reading for day	DPT 13.010/ DPT 13.013	send	Actuator sends added power in day mode	Visu, Diagnostic...	Communication object is shown at activated main meter
25	Main meter	Meter reading for night	DPT 13.010/ DPT 13.013	send	Actuator sends added power in night mode	Visu, Diagnostic...	Communication object is shown at activated main meter
26	Main meter	Reset	DPT 1.001	receive	Resetting the intermediate meter	Push Button, Visu...	Communication object is shown at activated main meter
27	Counter	Event A	DPT 1.010	send	Actuator sends achievement of the adjusted counter value	Actuator, Visu, Generating messages...	Communication object is shown at activated energy meter and Event A
28	Counter	Event B	DPT 1.010	send	Actuator sends achievement of the adjusted counter value	Actuator, Visu, Generating messages...	Communication object is shown at activated energy meter and Event B
29	Operating hours counter	Response operating hours	DPT 7.007	send	Actuator sends added operating hours	Visu, Diagnostic, Monitoring	Communication object is shown at activated operating hours counter, adjusted as incrementer
29	Operating hours counter	Time to next service	DPT 7.007	send	Actuator sends remaining operating hours until next service	Visu, Diagnostic, Monitoring	Communication object is shown at activated operating hours counter, adjusted as reverse counter
30	Operating hours counter	Reset operating hours	DPT 1.001	receive	Resetting the operating hours to zero	Visu, Diagnostic, Push Button	Communication object is shown at activated operating hours counter, adjusted as incrementer

Technical Manual Switch Actuator – active power meas.

30	Operating hours counter	Reset service	DPT 1.001	receive	Resetting the operating hours to parameterized value	Visu, Diagnostic, Push Button	Communication object is shown at activated operating hours counter, adjusted as reverse counter
31	Operating hours counter	Service required	DPT 1.001	send	Actuator sends On-telegram at expiration of service time	Visu, Diagnostic, Monitoring	Communication object is shown at activated operating hours counter, adjusted as reverse counter
+36	next Channel						

Table 2: Overview objects – Measurement

Technical Manual Switch Actuator – active power meas.

Nr.	Name	Object function	Data type	Direction	Info	Usage	Tip
Central objects:							
108/ 216	Central function	Switch	DPT 1.001	receive	Central switching On/Off	Visu, Diagnostic, Monitoring	Object is always shown
109/ 217	Central function	Lock hand operation	DPT 1.001	receive	locks manual control with an "on- telegram"	Push Button, Visu...	Object is always shown
110/ 218	Total active power	Total value	DPT 9.024/ DPT 14.056	send	Sending the total active power of all channels	Visu, Diagnostic, Monitoring	Object is shown when the total active power meter is active
111/ 219	Total current	Total value	DPT 7.012/ DPT 9.021/ DPT 14.019	send	Sending the total current of all channels	Visu, Diagnostic, Monitoring	Object is shown when the total current meter is active
113/ 221	Total active power	Exceeding of load	DPT 1.011	send	Sending an exceeding of load of all channels	Actuator, Visu, Generating of messages...	Object is shown when total active power meter and load monitoring is active
114/ 222	Total active power	Falling below of load	DPT 1.011	send	Sending an undercut of load of all channels	Actuator, Visu, Generating of messages...	Object is shown when total active power meter and load monitoring is active
115/ 223	Total current	Exceedance of current	DPT 1.011	send	Sending an exceeding of current of all channels	Actuator, Visu, Generating of messages...	Object is shown when total current meter and current monitoring is active
116/ 224	Total current	Lower deviation of current	DPT 1.011	send	Sending an undercut of current of all channels	Actuator, Visu, Generating of messages...	Objekt wird eingeblendet wenn Summenstrom und Stromüberwachung aktiviert wurde
117/ 225	Total intermediate meter	Active Energy Wh/kwh	DPT 13.010/ DPT 13.013	send	Actuator sends added load of all channels	Visu, Diagnostic...	Object is shown when intermediate meter of all channels is active
118/ 226	Total intermediate meter	Display costs in Euro	none, 4 Byte-Wert	send	Actuator sends added costs of all channels	Visu, Diagnostic...	Object is shown when intermediate meter of all channels is active

Technical Manual Switch Actuator – active power meas.

119/ 227	Total intermediate meter	Meter reading for day	DPT 13.010/ DPT 13.013	send	Actuator sends added load in day mode	Visu, Diagnostic...	Object is shown when intermediate meter of all channels is active
120/ 228	Total intermediate meter	Meter reading for night	DPT 13.010/ DPT 13.013	send	Actuator sends added load in night mode	Visu, Diagnostic...	Object is shown when intermediate meter of all channels is active
121/ 229	Total intermediate meter	Reset	DPT 1.001	receive	Resetting the intermediate meter	Push Button, Visu...	Object is shown when intermediate meter of all channels is active
122/ 230	Total main meter	Active Energy Wh/kwh	DPT 13.010/ DPT 13.013	send	Actuator sends added load of all channels	Visu, Diagnostic...	Object is shown when main meter of all channels is active
123/ 231	Total main meter	Display costs in Euro	none, 4 Byte-Wert	send	Actuator sends added costs of all channels	Visu, Diagnostic...	Object is shown when main meter of all channels is active
124/ 232	Total main meter	Meter reading for day	DPT 13.010/ DPT 13.013	send	Actuator sends added load in day mode	Visu, Diagnostic...	Object is shown when main meter of all channels is active
125/ 233	Total main meter	Meter reading for night	DPT 13.010/ DPT 13.013	send	Actuator sends added load in night mode	Visu, Diagnostic...	Object is shown when main meter of all channels is active
126/ 234	Total main meter	Reset	DPT 1.001	receive	Resetting the main meter	Push Button, Visu...	Object is shown when main meter of all channels is active
127/ 235	Total counter	Event A	DPT 1.010	send	Actuator sends achievement of the adjusted counter value	Actuator, Visu, Generating messages...	Object is shown when Event A is activated in the menu „Total energy meter and cost meter“
128/ 236	Total counter	Event B	DPT 1.010	send	Actuator sends achievement of the adjusted counter value	Actuator, Visu, Generating messages...	Object is shown when Event B is activated in the menu „Total energy meter and cost meter“
129/ 237	Electricity price for day	Enter the electricity tariff in cents	none – 2/4 Byte	receive	Actuator receives current electricity tariff	Visu...	Object is shown when parameter “Cost calculated over” in menu “Total energy meter and cost meter” is set to “one/two variable values”

Technical Manual Switch Actuator – active power meas.

130/ 238	Electricity price for night	Enter the electricity tariff in cents	none – 2/4 Byte	receive	Actuator receives current electricity tariff	Visu...	Object is shown when parameter “Cost calculated over” in menu “Total energy meter and cost meter” is set to “two variable values”
131/ 239	Current electricity price	Display electricity	none – 2/4 Byte	send	Actuator sends the currently set electricity tariff	Diagnostic, request	Object is always shown
132/ 240	Central function	Operating	DPT 1.001	send	Actuator sends cyclic operating telegram	Diagnostic, Visu...	Object can be activated in the general settings
133/ 241	Central function	Day/Night	DPT 1.001	receive	Aktor empfängt Tag/Nacht Umschaltung	Visu, Time switch, Glass-Operating Unit...	Object is shown when parameter “Control change day->night” in menu “Total energy meter and cost meter” is set to day/night object
134/ 242	Central function	Slave time	DPT 10.001	receive	Actuator receives time of day	Time Switch	Object is always shown
135/ 243	Central function	Voltage error	DPT 1.005	send	Actuator sends voltage error	Diagnostic, Visu...	Object is always shown
136/ 244	Central function	Group state	DPT 27.001	send	Actuator sends state of all channels	Diagnostic, Visu...	Object can be activated in the general settings
137/ 245	Central function	External active power	DPT 14.056	receive	Actuator receives external active power	additional switching actuator with active power measurement	Object is shown when total active power is activated

Table 3: Overview Communication objects - central functions

3.2 Default settings of the communication objects

The following chart shows the default settings of the communication objects:

Default settings									
Nr.	Name	Object Function	Length	Priority	C	R	W	T	U
Switch channel:									
0	Channel A	Switch on/off	1 Bit	Low	X		X		
1	Channel A	Staircase	1 Bit	Low	X		X		
2	Channel A	Block	1 Bit	Low	X		X		
3	Channel A	Scene	1 Byte	Low	X		X		
4	Channel A	Status	1 Bit	Low	X	X		X	
5	Channel A	Logic 1	1 Bit	Low	X		X		
6	Channel A	Logic 2	1 Bit	Low	X		X		
Active power meter:									
7	Active power meter	Active power	2 Byte/ 4 Byte	Low	X	X		X	
8	Active power meter	Current value	2 Byte/ 4 Byte	Low	X	X		X	
9	Active power meter	Voltage value	4 Byte	Low	X	X		X	
10	Advance power measurement	Apparent power in W/ Apparent power in kW/ Reactive power in W/ Reactive power in kW/ Power factor cos phi	4 Byte	Low	X	X		X	
11	Active power meter	Exceeding of load	1 Bit	Low	X	X		X	
12	Active power meter	Falling below of laod	1 Bit	Low	X	X		X	
13	Active power meter	Exceedance of current	1 Bit	Low	X	X		X	
14	Active power meter	Lower deviation of current	1 Bit	Low	X	X		X	
15	Active power meter	Exceedance of voltage	1 Bit	Low	X	X		X	
16	Active power meter	Lower deviation of voltage	1 Bit	Low	X	X		X	
17	Intermediate meter	Active energy Wh/kwh	4 Byte	Low	X	X		X	
18	Intermediate meter	Display costs in Euro	4 Byte	Low	X	X		X	
19	Intermediate meter	Meter reading for day	4 Byte	Low	X	X		X	
20	Intermediate meter	Meter reading for night	4 Byte	Low	X	X		X	

Nr.	Name	Object Function	Length	Priority	C	R	W	T	U
21	Intermediate meter	Reset	1 Bit	Low	X		X		
22	Main meter	Active energy Wh/kwh	4 Byte	Low	X	X		X	
23	Main meter	Display costs in Euro	4 Byte	Low	X	X		X	
24	Main meter	Meter reading for day	4 Byte	Low	X	X		X	
25	Main meter	Meter reading for night	4 Byte	Low	X	X		X	
26	Main meter	Reset	1 Bit	Low	X		X		
27	Counter	Event A	1 Bit	Low	X			X	
28	Counter	Event B	1 Bit	Low	X			X	
29	Operating hours counter	Response operating hours	2 Byte	Low	X	X		X	
29	Operating hours counter	Time to next service	2 Byte	Low	X	X		X	
30	Operating hours counter	Reset operating hours	1 Bit	Low	X		X		
30	Operating hours counter	Reset service	1 Bit	Low	X		X		
31	Operating hours counter	Service required	1 Bit	Low	X			X	
Central Objects:									
108/ 216	Central function	Switch	1 Bit	Low	X		X		
109/ 217	Central function	Lock hand operation	1 Bit	Low	X		X		
110/ 218	Total active power	Total value	2 Byte/ 4 Byte	Low	X	X		X	
111/ 219	Total current	Total value	2 Byte/ 4 Byte	Low	X	X		X	
113/ 221	Total active power	Exceeding of load	1 Bit	Low	X	X		X	
114/ 222	Total active power	Falling below of load	1 Bit	Low	X	X		X	
115/ 223	Total current	Exceedance of current	1 Bit	Low	X	X		X	
116/ 224	Total current	Lower deviation of current	1 Bit	Low	X	X		X	
117/ 225	Total intermediate meter	Active Energy Wh/kwh	4 Byte	Low	X	X		X	
118/ 226	Total intermediate meter	Display costs in Euro	4 Byte	Low	X	X		X	
119/ 227	Total intermediate meter	Meter reading for day	4 Byte	Low	X	X		X	
120/ 228	Total intermediate meter	Meter reading for night	4 Byte	Low	X	X		X	
121/ 229	Total intermediate meter	Reset	1 Bit	Low	X		X		

Nr.	Name	Object Function	Length	Priority	C	R	W	T	U
122/ 230	Total main meter	Active Energy Wh/kwh	4 Byte	Low	X	X		X	
123/ 231	Total main meter	Display costs in Euro	2/4 Byte	Low	X	X		X	
124/ 232	Total main meter	Meter reading for day	4 Byte	Low	X	X		X	
125/ 233	Total main meter	Meter reading for night	4 Byte	Low	X	X		X	
126/ 234	Total main meter	Reset	1 Bit	Low	X		X		
127/ 235	Total counter	Event A	1 Bit	Low	X			X	
128/ 236	Total counter	Event B	1 Bit	Low	X			X	
129/ 237	Electricity price for night	Enter the electricity tariff in cents	2/4 Byte	Low	X		X		
130/ 238	Current electricity price	Display electricity	2/4 Byte	Low	X		X		
131/ 239	Central function	Operating	4 Byte	Low	X	X		X	
132/ 240	Central function	Day/Night	1 Bit	Low	X		X		
133/ 241	Central function	Slave time	1 Bit	Low	X		X		
134/ 242	Central function	Voltage error	3 Byte	Low	X		X		
135/ 243	Central function	Group state	1 Bit	Low	X	X		X	
136/ 244	Central function	External active power	4 Byte	Low	X	X		X	
137/ 245	Electricity price for night	Enter the electricity tariff in cents	4 Byte	Low	X		X		

Table 4: Communication objects – default settings

You can see the default values for the communication objects from the upper chart. According to requirements the priority of the particular communication objects as well as the flags can be adjusted by the user. The flags allocates the function of the objects in the programming thereby stands C for communication, R for Read, W for write, T for transmit and U for update.

4 Parameter – Switch Channel

4.1 Identical parameter

The following parameters are as well available at channels selected as switch as at channels selected as staircase.

4.1.1 Relay operating mode

The following illustration shows the setting options for this parameter:

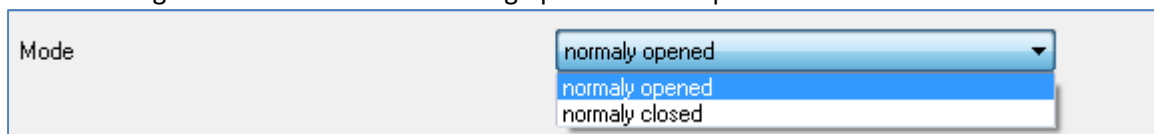

Figure 2: Operating mode

The following chart shows the dynamic range for this parameter:

ETS-text	Dynamic range [default value]	comment
Mode	<ul style="list-style-type: none"> ▪ normally opened ▪ normally closed 	Relay operating mode of the channel

Table 5: Operating mode

The following diagram shows the behavior of the relay operating mode normally closed and normally opened. The input for the channels is a KNX-telegram, which sends alternating 0-signals and 1-signals:

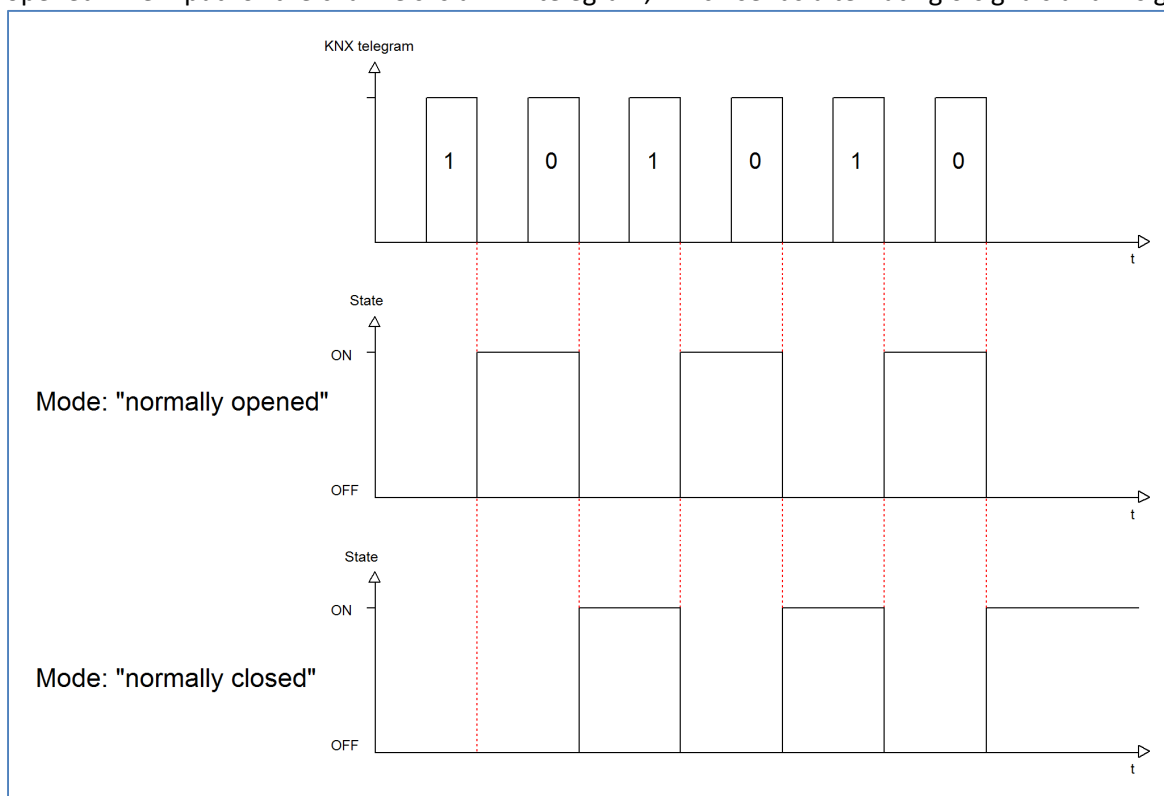

4.1.2 Central function

The following illustration shows the setting options at the ETS-Software:

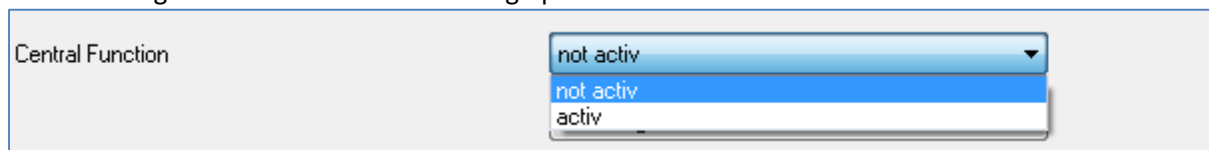

Figure 3: Central function

The following chart shows the dynamic range for this parameter:

ETS-text	Dynamic range [default value]	comment
Central function	<ul style="list-style-type: none"> ▪ not active ▪ active 	switches the central function on/off for this channel

Table 6: Central function

The central function can be switched on/off for every channel. For switching on this function, you have to choose the option “active”. By calling the central communication object, all channels with an activated central function are switched on with their current parameterization. So switch-on delays or staircase functions are still kept.

The central function can make programming much easier and your project can become more clear.

The following chart shows the associated communication object:

Number	Name	Length	Usage
16	Central function	1 Bit	central switching of the channels number depends to the number of channels

Table 7: Communication object central function

4.1.3 Behavior at block/unblock

The following illustration shows the setting options at the ETS-Software:

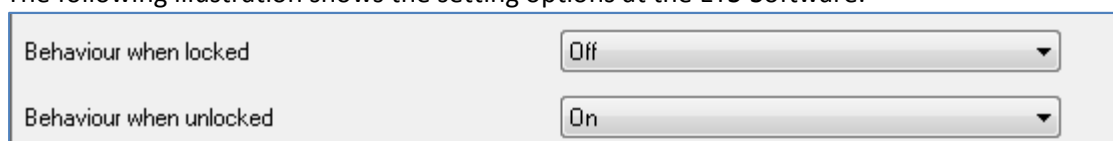

Figure 4: Blocking function

The following chart shows the dynamic range for this parameter:

ETS-text	Dynamic range [default value]	comment
Behavior when locked Behavior when unlocked	<ul style="list-style-type: none"> ▪ On ▪ Off ▪ no change 	Behavior to a blocking/unblocking process

Table 8: Behavior at block/unblock

The blocking function gets active, when the corresponding communication object becomes a logical “1”. By sending a logical “0”, the blocking function can be deactivated again.

The parameter “Behavior when locked” defines an action for the output at activating the blocking process. There are the setting on, off and no change available. The same settings are also available for the “Behavior when unlocked”. This action is called when the blocking function is deactivated again.

The following chart shows the corresponding communication object:

Number	Name	Length	Usage
3	Block	1 Bit	blocks the channel

Table 9: Communication object blocking function

The following diagram describes the blocking process. For the “Behavior when locked”, the action on was parameterized and for the “Behavior when unlocked” the action off was parameterized:

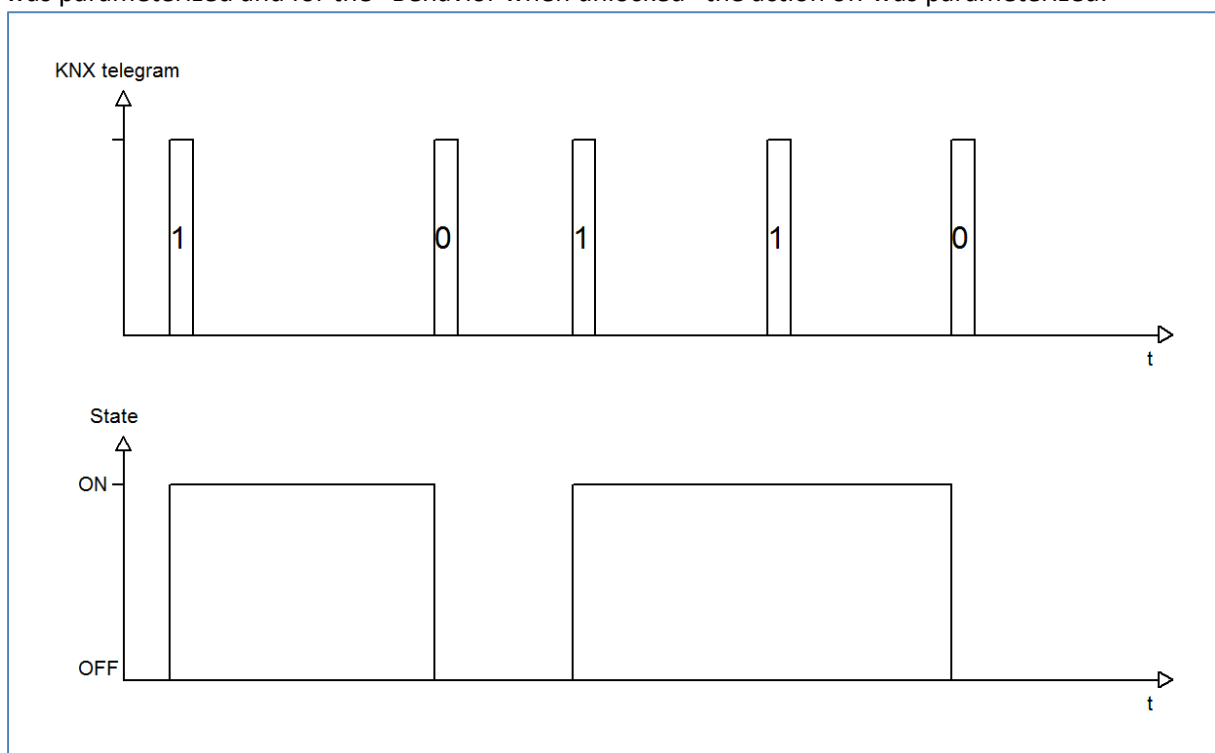

The KNX telegram shows which values are send to the blocking object. By sending a logical “1”, the blocking function is activated and the channel is switched on. The blocking function is deactivated again by sending a logical “0”. So the channel is switched off.

4.2 Switching output

The following parameters, which are described at the headings 4.3.x, are only available at channels selected as switch.

4.2.1 Overview

By choosing a channel as switch, a sub menu, called Channel A Switching, appears for this channel at the left drop down menu.

The sub menu is shown at the following illustration:

Mode	normally open
On delay [s]	0
Off delay [s]	0
Central function	not activ
Behaviour when locked	no change
Behaviour when unlocked	no change
Logical functions	not activ
Scene	not activ

Figure 5: Switching output

The chart shows the possible settings for switching outputs:

ETS-text	Dynamic range [default value]	comment
Mode	<ul style="list-style-type: none"> ▪ normally opened ▪ normally closed 	Operation mode of the channel
On-Delay	0...30000 sec [0=no delay]	Switch on delay of the channel in seconds
Off-Delay	0...30000 sec [0=no delay]	Switch off delay of the channel in seconds
Central function	<ul style="list-style-type: none"> ▪ not active ▪ active 	Activates the central function for this channel
Behavior when locked	<ul style="list-style-type: none"> ▪ Off ▪ On ▪ no change 	Action for activating the blocking process
Behavior when unlocked	<ul style="list-style-type: none"> ▪ Off ▪ On ▪ no change 	Action for deactivating the blocking process
Logic function	<ul style="list-style-type: none"> ▪ not active ▪ with one object ▪ with two objects 	Activation of the logic function with one or two objects
Logic operation	<ul style="list-style-type: none"> ▪ And ▪ Or 	Selection of the logic function only available, when the logic function was activated
Scene	<ul style="list-style-type: none"> ▪ not active ▪ active 	Activation of the scene function by activation this parameter a new sub menu appears (have a look at 4.4.4)

Table 10: Switching output

4.2.2 On-/Off-delay

The following illustration shows the setting options at the ETS-Software:

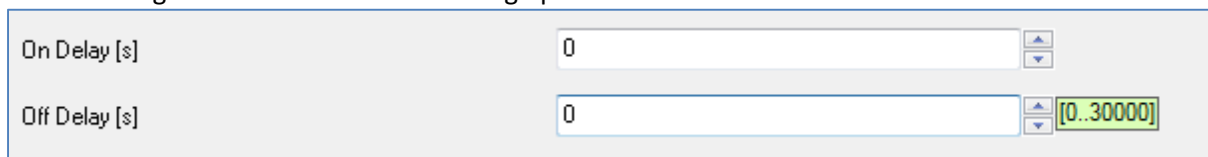

Figure 6: On/Off delay

The on-delay causes a delayed switch of the channel. At sending an on-signal to the channel, first the adjusted on delay time expires and afterwards the channel will be switched on.

The off delay works on the same principle. At sending an off-signal, first the adjusted off delay time expires and afterwards the channel will be switched off.

Both functions work as well alone as combined. By adjusting "0 seconds" for a delay the function is switched off.

The following diagram describes the combination of on and off delay:

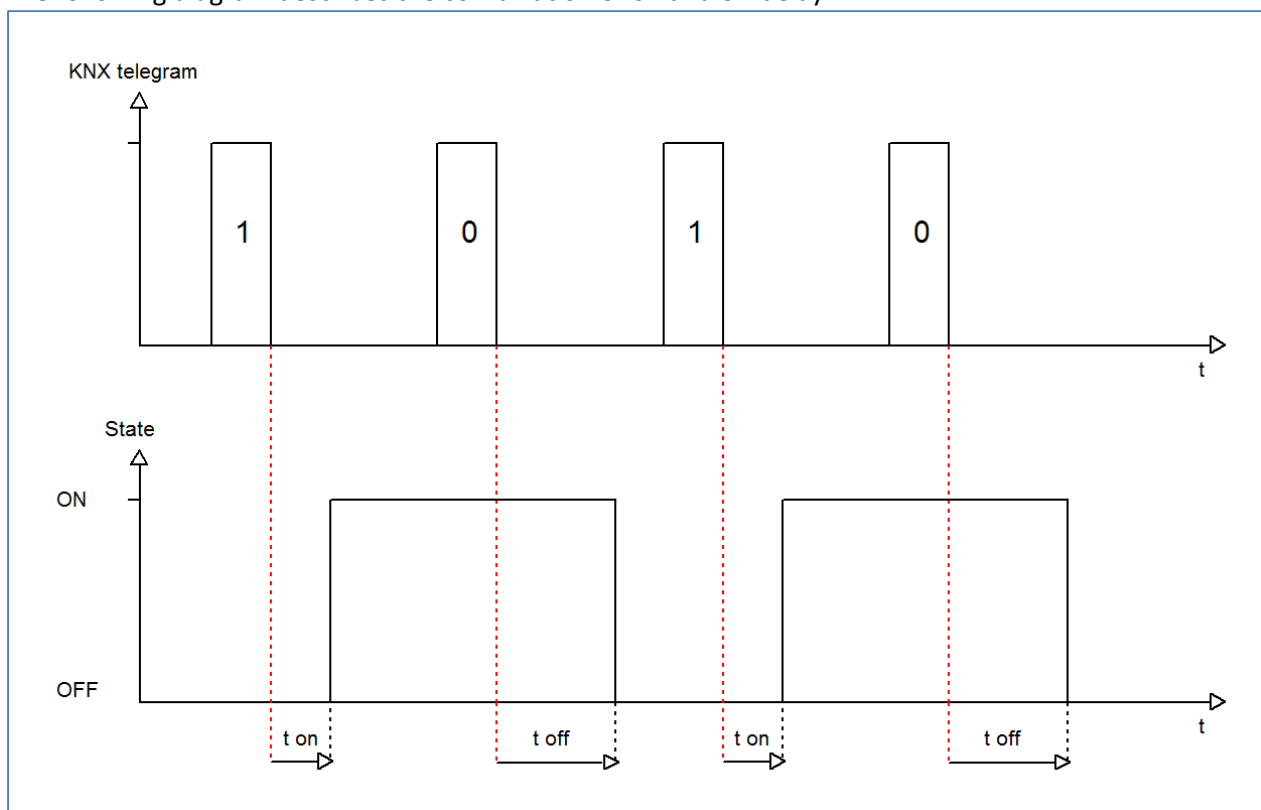

4.2.3 Logical functions

The following illustration shows the setting options at the ETS-Software:

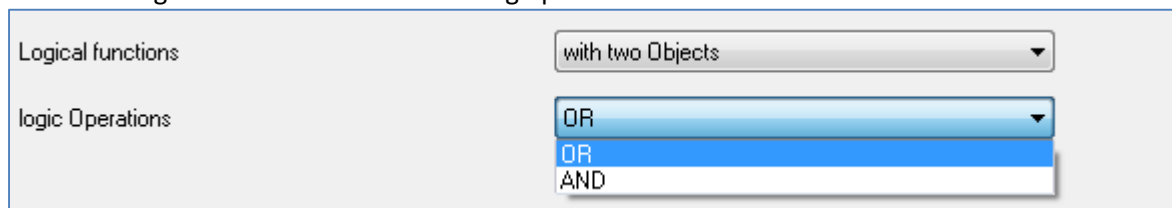

Figure 7: Logical functions

The logic function can be activated with one or two objects. The objects are the inputs of the logic block. Furthermore you can choose between an AND-function and an OR-function. The following figure shows an overview of the basic logic function with two objects:

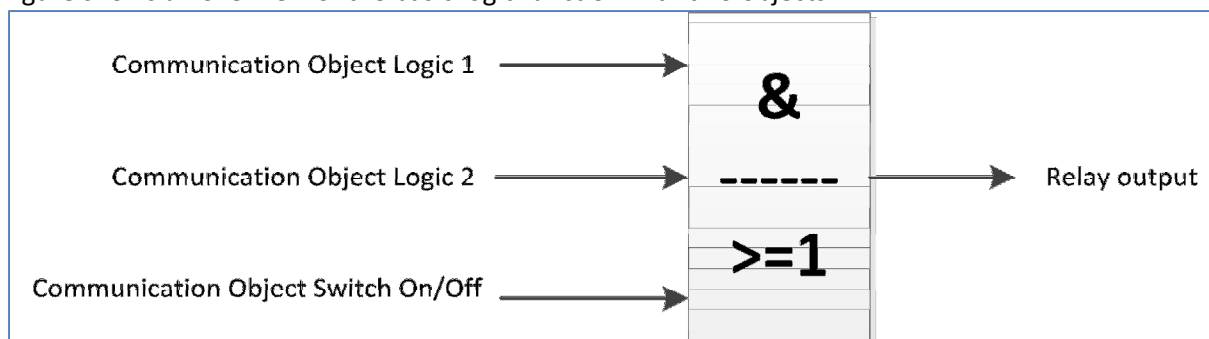

Figure 8: Overview Logic function

The logic function consists of the activated input objects and the switching object for each channel. The output of the logic is the respective relay output of the channel, so the physical switching of the channel.

The following chart shows the relevant communication objects:

Number	Name	Length	Usage
6	Logic 1	1 Bit	Logic object 1, is the first input for the logic block
7	Logic 2	1 Bit	Logic object 2, is the second input for the logic block

Table 11: Communication objects logic

The following table illustrates the two logic functions:

AND-Connection

OR-Connection

Switch On/Off	Logic 1	Logic 2	Channel switched?	Switch On/Off	Logic 1	Logic 2	Channel switched?
0	0	0	Nein	0	0	0	Nein
0	0	1	Nein	0	0	1	Ja
0	1	0	Nein	0	1	0	Ja
0	1	1	Nein	0	1	1	Ja
1	0	0	Nein	1	0	0	Ja
1	0	1	Nein	1	0	1	Ja
1	1	0	Nein	1	1	0	Ja
1	1	1	Ja	1	1	1	Ja

Table 12: Logic function

4.2.4 Scene function

When functions of different groups (e.g. light, heating and shutter) shall be changed simultaneously with only one keystroke, it is practical to use the scene function. By calling a scene, you can switch the lights to a specific value, drive the shutter to an absolute position, switch the heating to the day mode and switch the power supply of the sockets on. The telegrams of these functions can have as well different formats as different values with different meaning (e.g. “0” for switch the lights off and open the shutters). If there were no scene function, you would have to send a single telegram for every actuator to get the same function.

The scene function of the switch actuator enables you to connect the channels of the switch actuator to a scene control. For that, you have to assign the value to the appropriated space (scene A..H). It is possible to program up to 8 scenes per switching output. When you activate the scene function at the switching output, a new sub menu for the scenes appears at the left drop down menu. There are settings to activate single scenes, set values and scene numbers and switch the memory function on/off at this sub menu.

Scenes are activated by receiving their scene numbers at the communication object for the scenes. If the memory function of the scenes is activated, the current value of the channel will be saved at the called scene number.

The communication objects of the scenes have always the length of 1 byte.

The following illustration shows the setting options at the ETS-Software for activating the scene function:

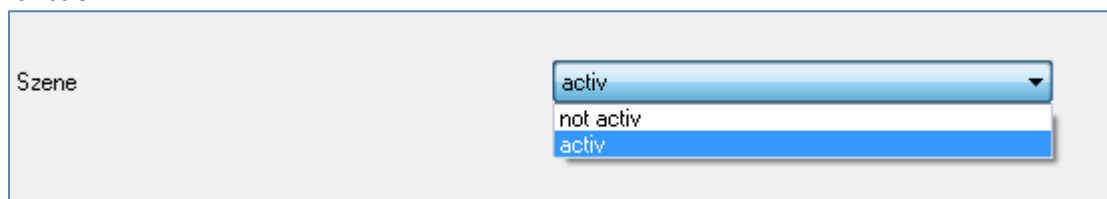

Figure 9: Scene function

The following chart shows the relevant communication object:

Number	Name	Length	Usage
4	Scene	1 Byte	Call of the scene

Table 13: Communication object scene

For calling a certain scene, you have to send the value for the scene to the communication object. The value of the scene number is always one number less than the adjusted scene number. For calling scene 1, you have to send a “0”. So the scene numbers have the numbers from 1 to 64, but the values for the scenes only from 0 to 63.

If you want to call scenes by a binary input or another KNX device, you have to set the same number at the calling device as at the receiving device. The calling device, e.g. a binary input, sends automatically the right value for calling the scene.

There are up to 8 storage options for scenes at every channel.
 These 8 storage options can get any of the possible 64 scene numbers.

Channel A, Scene	
Save scene	enabled
Scene A	Off
Scene Number A	1
Scene B	Off
Scene Number B	2
Scene C	Off
Scene Number C	3
Scene D	Off
Scene Number D	4
Scene E	Off
Scene Number E	5
Scene F	Off
Scene Number F	6
Scene G	Off
Scene Number G	7
Scene H	Off
Scene Number H	8

Figure 10: Sub function scene

The chart shows the possible settings for scenes, which are identical for all channels. The settings are available at the sub menu for the scenes:

ETS-text	Dynamic range [default value]	comment
Save scene	<ul style="list-style-type: none"> ▪ disabled ▪ enabled 	Learning of scenarios; enable/disable memory function
Scene A	<ul style="list-style-type: none"> ▪ Off ▪ On 	Activation of the scene A
Scene number A	1-64 [1]	Scene number; Calling value = 1 less than the adjusted scene number
Scene B	<ul style="list-style-type: none"> ▪ Off ▪ On 	Activation of the scene B
Scene number B	1-64 [1]	Scene number; Calling value = 1 less than the adjusted scene number
Scene C	<ul style="list-style-type: none"> ▪ Off ▪ On 	Activation of the scene C
Scene number C	1-64 [1]	Scene number; Calling value = 1 less than the adjusted scene number
Scene D	<ul style="list-style-type: none"> ▪ Off ▪ On 	Activation of the scene D
Scene number D	1-64 [1]	Scene number; Calling value = 1 less than the adjusted scene number
Scene E	<ul style="list-style-type: none"> ▪ Off ▪ On 	Activation of the scene E
Scene number E	1-64 [1]	Scene number; Calling value = 1 less than the adjusted scene number
Scene F	<ul style="list-style-type: none"> ▪ Off ▪ On 	Activation of the scene F
Scene number F	1-64 [1]	Scene number; Calling value = 1 less than the adjusted scene number
Scene G	<ul style="list-style-type: none"> ▪ Off ▪ On 	Activation of the scene G
Scene number G	1-64 [1]	Scene number; Calling value = 1 less than the adjusted scene number
Scene H	<ul style="list-style-type: none"> ▪ Off ▪ On 	Activation of the scene H
Scene number H	1-64 [1]	Scene number; Calling value = 1 less than the adjusted scene number

Table 14: Parameter scene

For calling a scene or saving a new value for the scene, you have to send the accordingly code to the relevant communication object for the scene:

Scene	Retrieve		Save	
	Hex.	Dez.	Hex.	Dez.
1	0x00	0	0x80	128
2	0x01	1	0x81	129
3	0x02	2	0x82	130
4	0x03	3	0x83	131
5	0x04	4	0x84	132
6	0x05	5	0x85	133
7	0x06	6	0x86	134
8	0x07	7	0x87	135
9	0x08	8	0x88	136
10	0x09	9	0x89	137
11	0x0A	10	0x8A	138
12	0x0B	11	0x8B	139
13	0x0C	12	0x8C	140
14	0x0D	13	0x8D	141
15	0x0E	14	0x8E	142
16	0x0F	15	0x8F	143
17	0x10	16	0x90	144
18	0x11	17	0x91	145
19	0x12	18	0x92	146
20	0x13	19	0x93	147
21	0x14	20	0x94	148
22	0x15	21	0x95	149
23	0x16	22	0x96	150
24	0x17	23	0x97	151
25	0x18	24	0x98	152
26	0x19	25	0x99	153
27	0x1A	26	0x9A	154
28	0x1B	27	0x9B	155
29	0x1C	28	0x9C	156
30	0x1D	29	0x9D	157
31	0x1E	30	0x9E	158
32	0x1F	31	0x9F	159

Table 15: Calling and saving scenes

4.2.4.1 Scene programming example

When the scene function is activated for one channel, a new sub menu for the scene of this channel appears. Up to 8 scenes can be adjusted at this sub menu. Every scene gets one scene number, which enables the calling of the scene. You can adjust one specific state for every scene. So you can switch the channel off, with the setting “Off” or switch the channel on with the setting “On”. When the scene is called, the adjusted parameterization of the channel is kept (e.g. on delay, off delay, ...). To note at the scene programming is that if you want to call 2 or more channels with the same scene number, you have to set the both communication objects for the scenes to the same group address. By sending the calling value, both scenes are called. Your programming can become much clearer if you divide your group addresses by scene numbers. If now one channel shall react to 8 scenes, you will have to connect the communication object for the scenes to 8 group addresses.

The following illustrations shall make the division clearly:

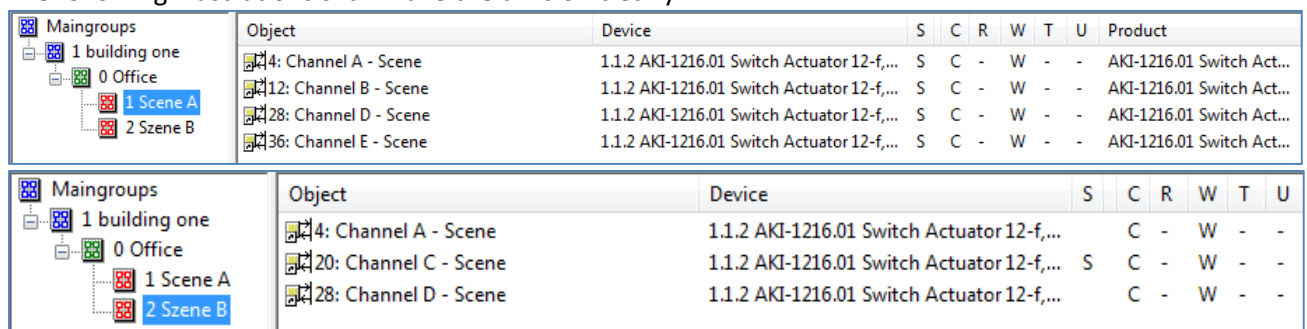

Object	Device	S	C	R	W	T	U	Product
4: Channel A - Scene	1.1.2 AKI-1216.01 Switch Actuator 12-f,...	S	C	-	W	-	-	AKI-1216.01 Switch Act...
12: Channel B - Scene	1.1.2 AKI-1216.01 Switch Actuator 12-f,...	S	C	-	W	-	-	AKI-1216.01 Switch Act...
28: Channel D - Scene	1.1.2 AKI-1216.01 Switch Actuator 12-f,...	S	C	-	W	-	-	AKI-1216.01 Switch Act...
36: Channel E - Scene	1.1.2 AKI-1216.01 Switch Actuator 12-f,...	S	C	-	W	-	-	AKI-1216.01 Switch Act...

Object	Device	S	C	R	W	T	U
4: Channel A - Scene	1.1.2 AKI-1216.01 Switch Actuator 12-f,...		C	-	W	-	-
20: Channel C - Scene	1.1.2 AKI-1216.01 Switch Actuator 12-f,...	S	C	-	W	-	-
28: Channel D - Scene	1.1.2 AKI-1216.01 Switch Actuator 12-f,...		C	-	W	-	-

Figure 11: Programming of scenes

The channels A and D shall react to the call of scene A and scene B. So they are connected to both group addresses.

Furthermore you can save scenes at the according scene numbers. For that you have to activate the memory function at a channel of the switch actuator. Now you can call scenes by a binary input with a short keystroke and save scenes by a long keystroke. The adjusted value for the scene is overwritten by the current state of the actuator, when you save the scenes. At the next call of the scene, the scene will be called with the new value.

4.3 Staircase

The following parameters, which are described at the headings 4.4.x, are only available at channels selected as staircase.

4.3.1 Overview

By choosing a channel as staircase, a sub menu, called Channel A Staircase, appears for this channel at the left drop down menu.

The sub menu is shown at the following illustration:

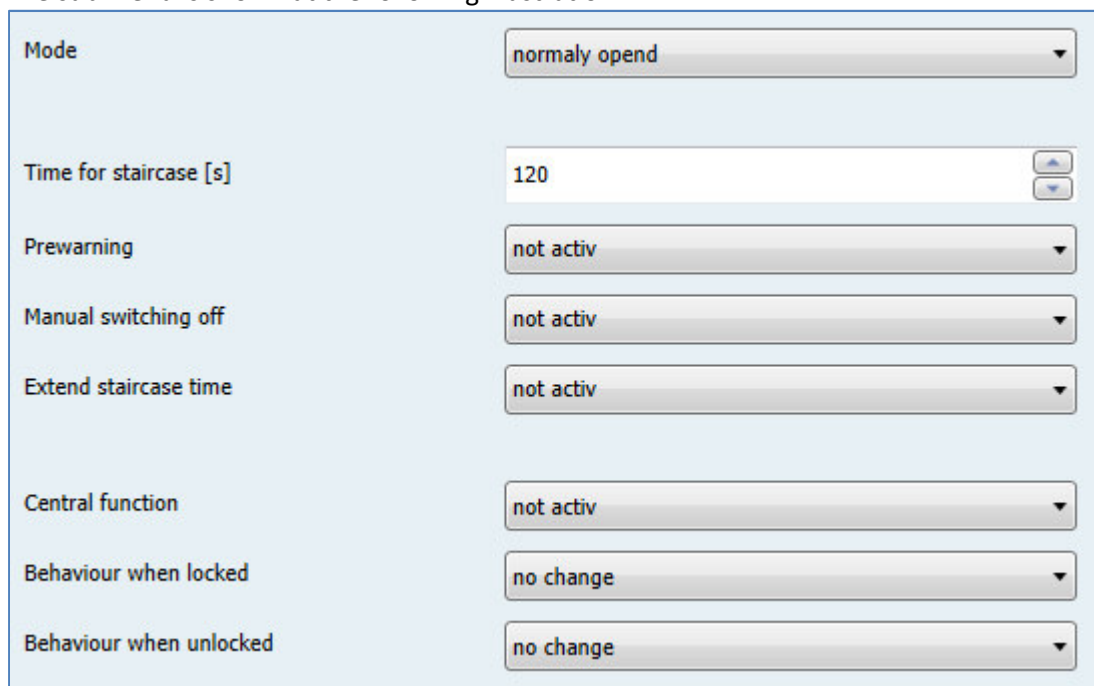

Mode	normally open
Time for staircase [s]	120
Prewarning	not activ
Manual switching off	not activ
Extend staircase time	not activ
Central function	not activ
Behaviour when locked	no change
Behaviour when unlocked	no change

Figure 12: Staircase

The chart shows all possible settings for staircase outputs:

ETS-text	Dynamic range [default value]	comment
Mode	<ul style="list-style-type: none"> ▪ normally opened ▪ normally closed 	Operation mode of the channel
Time for staircase [s]	0...65535 sec [120 sec]	Duration of the switching process
Prewarning	<ul style="list-style-type: none"> ▪ not active ▪ active 	Activates the prewarning function
Warning time [s]	0...65535 sec [120 sec]	Duration of the warning; Only available when warning is activated
Prewarning time [s]	0...65535 sec [120 sec]	Adjustment, how long the light shall be switched on after the warning; Whole duration of the warning process is the sum of the 3 times: Staircase time, warning and prewarning Only available when warning is activated
Manual switching off	<ul style="list-style-type: none"> ▪ not active ▪ active 	Activation of the manual turn off of the staircase
Extend staircase time	<ul style="list-style-type: none"> ▪ not active ▪ active 	Activation of the extension of the staircase
Central function	<ul style="list-style-type: none"> ▪ not active ▪ active 	Activates the central function for this channel
Behavior when locked	<ul style="list-style-type: none"> ▪ Off ▪ On ▪ no change 	Action for activating the blocking process
Behavior when unlocked	<ul style="list-style-type: none"> ▪ Off ▪ On ▪ no change 	Action for deactivating the blocking process

Table 16: Parameter staircase

4.3.2 Staircase time

The following illustration shows the setting options at the ETS-Software:

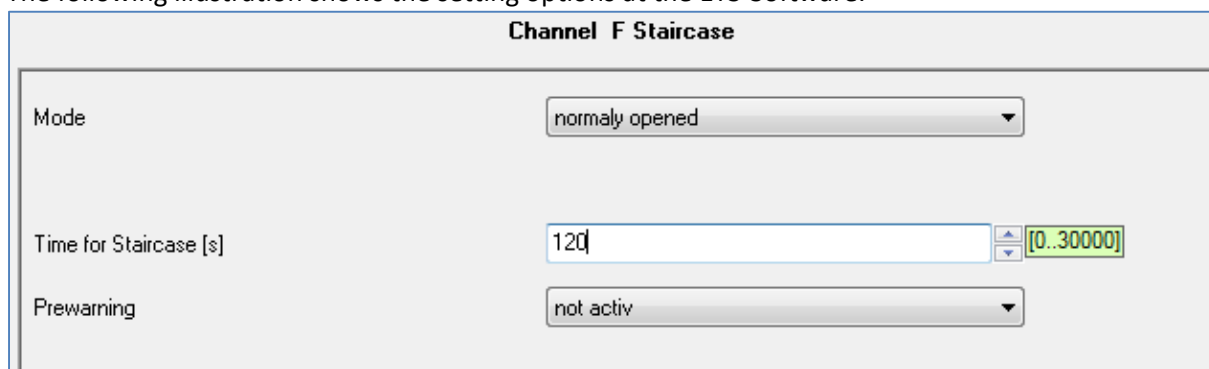

Figure 13: Staircase time

The staircase function is activated by choosing a channel as staircase. This function enables an automatic turn off of the channel after an adjusted time, called “time for staircase”. The time for staircase can be parameterized freely. By sending an “on-signal” at the communication object, the channel is switched on and the time runs out. After the time is ran out, the channel is switched off automatically. There are a lot of further functions to adjust the staircase function. These functions are described at the following segments.

The following chart shows the relevant communication object:

Number	Name	Length	Usage
1	Staircase	1 Bit	Calling of the staircase function

Table 17: Communication object staircase

4.3.3 Prewarning und Warning

The following illustration shows the setting options at the ETS-Software:

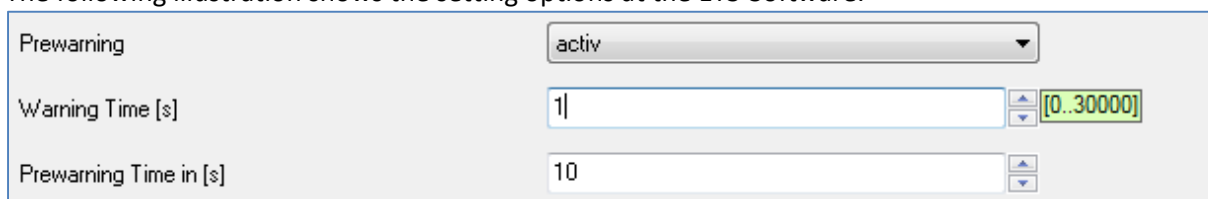
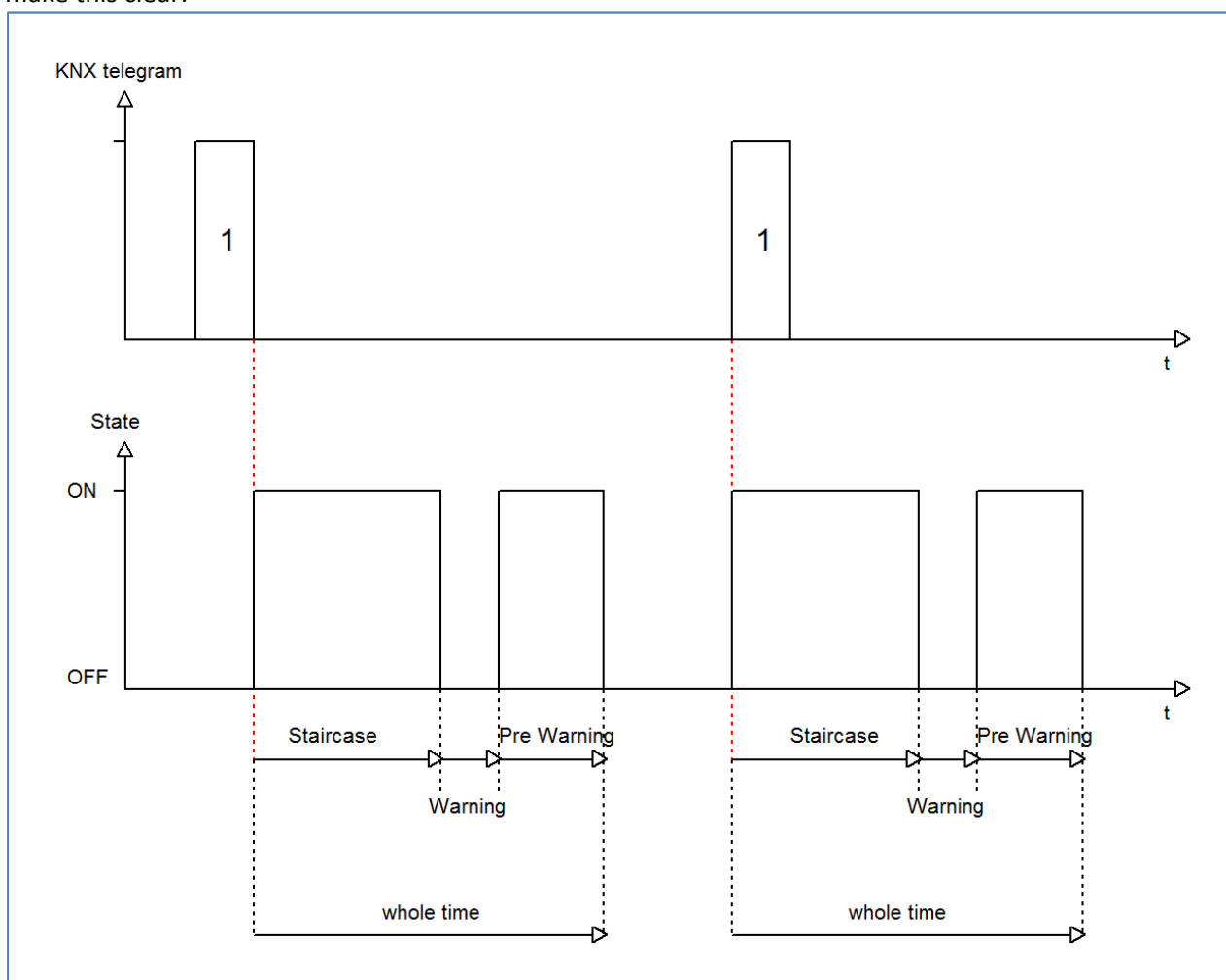

Figure 14: Warning timer & prewarning time

The warning function can be activated by adjusting the parameter “Prewarning” as active. Now, you can adjust warning time and prewarning time.

The warning function is for warning that the staircase time ran almost out and the lights are switched off soon. This warning happens trough a short turn off the lights. The duration of the turn off is indicated by the warning time. A value of 1-3s is advisable for this parameter. When the warning time runs out, the lights will be switched on again for the adjusted prewarning time. Now you have the opportunities to extend the staircase time, when this parameter was activated, or leave the staircase. A dynamic programming is advisable for this time. So you can adapt this time to spatial conditions (next switch, length of the staircase, etc.).

The whole duration of the switching process is the sum of the 3 times. The following diagram shall make this clear:



4.3.4 Manual switch off

The following illustration shows the setting options at the ETS-Software:

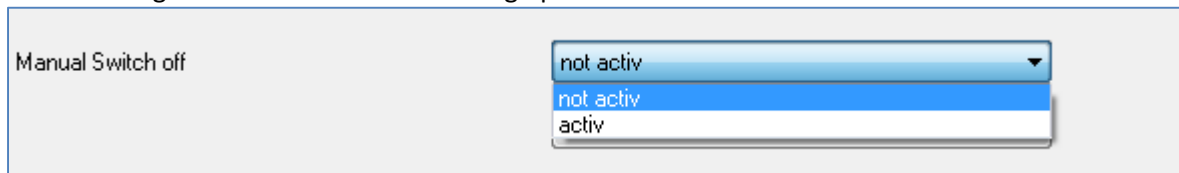

Figure 15: Manual switch off

By activation this function, you can switch the channel off before the staircase time runs out. For switching off the channel, you have to send a logical “0” to the communication object for switching the staircase function (have a look at Table 17: Communication object staircase). When this function is not activated, the channel switches only off after the staircase time runs out.

4.3.5 Extend staircase time

The following illustration shows the setting options at the ETS-Software:

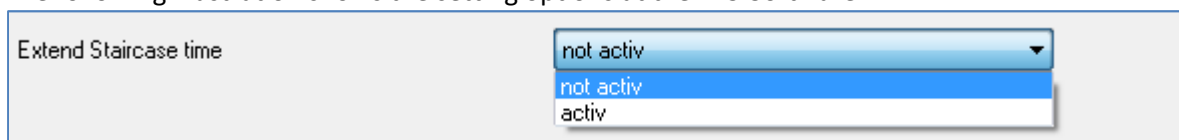
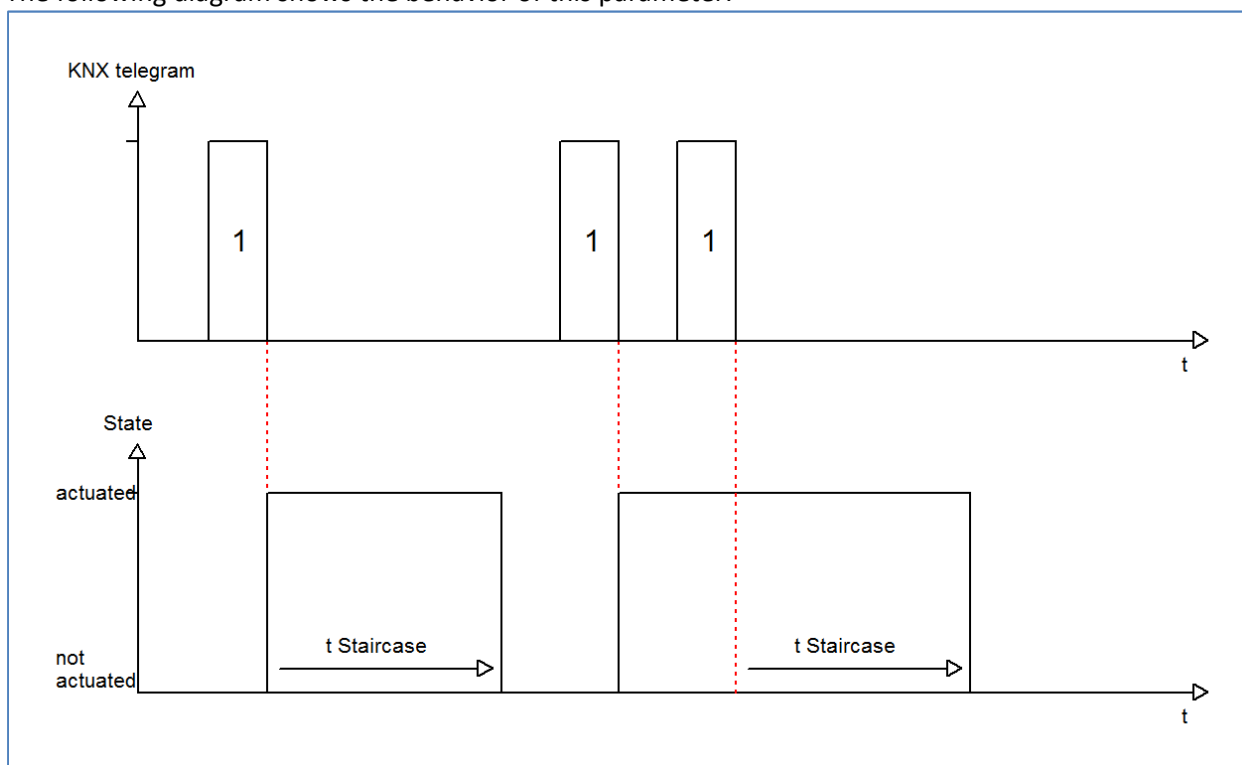

Figure 16: Extend staircase time

By activating this function, the staircase time is retriggerable. That means, when the staircase time runs already out to 2/3, you can restart the time by sending a new on-signal to the communication object of the staircase function (have a look at Table 17: Communication object staircase).

The following diagram shows the behavior of this parameter:



5 Parameter - Measurement

The following parameters are only in the RF socket with active power meter, RF AZK1ST.01, available.

5.1 Active power measurement

The following figure shows the menu active power measurement:

Enable active power measurement	yes
Object selection	4Byte floating value in W (DPT 14.056)
Send value at changes	7%
Send cyclic	no send
Monitoring exceedance of load	activ
Value for exceedance of load in W [0...3680]	100
Hysteresis in %	10
Behavior at exceeding	send OFF-telegram
Behavior at not exceeding	send nothing
Send cyclic	no send
Retention time by exceedance in sec.	0
Monitoring lower deviation of load	not activ

Figure 17: Menu "Active power measurement"

The following table shows the available settings:

ETS-text	Dynamic range [default value]	comment
General Settings		
Object selection	<ul style="list-style-type: none"> ▪ 4 Byte floating value in W (DPT14.056) ▪ 2 Byte floating value in kW (DPT9.024) 	defines the communication object of the measured active power
Send value at changes	no send, 5%-75% [no send]	defines the sending behavior of the measured active power
Send cyclic	no send, 5min-24h [no send]	defines the sending behavior of the measured active power
Settings for load monitoring(adjustable for exceeding and underflow):		
Value for exceedance/lower deviation of load	0 - 3680	defines the threshold for triggering an action for exceedance/deviating
Hysteresis in %	10-100% [10%]	defines the hysteresis
Behavior at exceeding/deviating	<ul style="list-style-type: none"> ▪ send nothing ▪ send ON-telegram ▪ send OFF-telegram ▪ send ON-telegram and channel OFF ▪ send OFF-telegram and channel OFF 	defines the action for exceedance/deviating of the set threshold: Send ON/OFF telegram: The object sends the adjusted telegram. Send ON/OFF telegram and channel OFF: The object sends the adjusted telegram and the channel is switched off
Behavior at not exceeding/deviating	<ul style="list-style-type: none"> ▪ send nothing ▪ send ON-telegram ▪ send OFF-telegram ▪ send ON-telegram and channel OFF ▪ send OFF-telegram and channel OFF 	defines the action for exceedance/deviating of the adjusted threshold; description see before
Send cyclic	no send, 5min-24h [no send]	The telegram for exceedance/deviating is sent cyclic
Retention time by exceedance/deviating in sec.	0-30000 [0]	defines a retention time, which must run out at an exceedance/deviating before a telegram is sent

Table 18: Menu "Active power measurement"

The active power measurement possible by simultaneous measurement of current and voltage output of the real active power. So the returned value is no longer a "theoretical" power at rated voltage, but the real power.

For the active power measurement, a monitoring of the load can be enabled and triggering specific actions. At the exceedance of load, the **hysteresis** causes a shift of the cut-off threshold. So, a hysteresis of 10% and a value for load exceeding of 100W causes a value for exceedance of 100W, which is only turned off when the measured value falls below 90W. In the underrun, a hysteresis of 10% and a value for underrun of 100W causes an active lower deviation of load at 100W, which is released until the value exceeds 110W again.

The **retention time by exceedance/deviating** specifies how long an exceedance/deviation must be measured for the output before the action for exceedance/deviation is triggered. So a retention time by exceedance of 10s causes that an exceedance must be measured for 10s before the action for exceedance is triggered. The retention time works with the hysteresis output. Thus, if an exceedance is measured, the power must fall below the hysteresis value for stopping the retention time timer.

The following table shows the available communication objects:

Number	Name	Length	Usage
8	Active power	2 Byte/ 4 Byte	Sending the measured active power
13	Exceedance of load	1 Bit	Sending an exceedance of load
14	Lower deviation of load	1 Bit	Sending a deviation of load

Table 19: Communication objects power measurement

5.1.1 Advanced power output

The following figure shows the settings for the advanced power output:

Enable advanced power output	Yes
Object setting	Power factor in cos phi (DPT 14.057)
Send value at change	no send
Send value cyclic	no send

Figure 18: Advanced power output

If the advanced power output is active, the following settings are available:

ETS-text	Dynamic range [default value]	comment
Object setting	<ul style="list-style-type: none"> ▪ Apparent power in W (DPT14.056) ▪ Apparent power in kW (DPT9.024) ▪ Reactive power in W (DPT14.056) ▪ Reactive power in kW (DPT9.024) ▪ Power factor in cos Phi (DPT14.057) 	defines which advanced power output is sent
Send value at change	no send, 5%-75% [no send]	defines the sending behavior at changes of the advanced power output
Send value cyclic	no send, 5min-24h [no send]	defines the cyclic sending behavior of the advanced power output

Table 20: Advanced power output

The following table shows the available communication objects:

Number	Name	Length	Usage
10	Apparent power in W/kW	2 Byte/ 4 Byte	Sending the measured apparent power = the product of voltage and current
10	Reactive power in W/kW	2 Byte/ 4 Byte	Sending the measured reactive power = the inductive/capacitive part of the power
10	Power factor cos Phi	4 Byte	Sending the power factor cos Phi = Relation of active power to apparent power

Table 21: Communication objects advanced power measurement

5.2 Current measurement

The following figure shows the menu current measurement:

Enable current measurement	yes
The measured total current consists of active current and reactive current	<-Tip
Object selection	Value in mA (DPT 7.012)
Send value at changes	8%
Send cyclic	no send
Monitoring exceedance of current	activ
Value for exceedance of current in mA [3... 16000]	100
Hysteresis in %	10
Behavior at exceeding	send OFF-telegram
Behavior at not exceeding	send nothing
Send cyclic	no send
Retention time by exceedance in sec.	0
Monitoring lower deviation of current	not activ

Figure 19: Menu current measurement

The following table shows the available settings:

ETS-text	Dynamic range [default value]	comment
General Settings		
Object selection	<ul style="list-style-type: none"> ▪ Value in mA (DPT7.012) ▪ Floating value in mA (DPT9.021) ▪ Floating value in A (DPT14.019) 	defines the communication object of the measured current
Send value at changes	no send, 5%-75% [no send]	defines the sending behavior of the measured current
Send cyclic	no send, 5min-24h [no send]	defines the sending behavior of the measured current

Settings for current monitoring(adjustable for exceeding and underflow):		
Value for exceedance/lower deviation of load	0 - 16000	defines the threshold for triggering an action for exceedance/deviating
Hysteresis in %	10-100% [10%]	defines the hysteresis
Behavior at exceeding/deviating	<ul style="list-style-type: none"> ▪ send nothing ▪ send ON-telegram ▪ send OFF-telegram ▪ send ON-telegram and channel OFF ▪ send OFF-telegram and channel OFF 	defines the action for exceedance/deviating of the set threshold: Send ON/OFF telegram: The object sends the adjusted telegram. Send ON/OFF telegram and channel OFF: The object sends the adjusted telegram and the channel is switched off
Behavior at not exceeding/deviating	<ul style="list-style-type: none"> ▪ send nothing ▪ send ON-telegram ▪ send OFF-telegram ▪ send ON-telegram and channel OFF ▪ send OFF-telegram and channel OFF 	defines the action for exceedance/deviating of the adjusted threshold; description see before
Send cyclic	no send, 5min-24h [no send]	The telegram for exceedance/deviating is sent cyclic
Retention time by exceedance/deviating in sec.	0-30000 [0]	defines a retention time, which must run out at an exceedance/deviating before a telegram is sent

Table 22: Menu current measurement

The behavior of the hysteresis and the retention time is described in detail in 5.1 Active power measurement.

The following table shows the available communication objects:

Number	Name	Length	Usage
9	Current value	2 Byte/ 4 Byte	Sending the measured current value
13	Exceedance of current	1 Bit	Sending an exceedance of load
14	Lower deviation of current	1 Bit	Sending a deviation of load

Table 23: Communication objects current measurement

5.3 Voltage measurement

The following figure shows the menu voltage measurement:

Enable voltage measurement	yes
Send value at changes	8%
Send cyclic	no send
Monitoring exceedance of voltage	activ
Value for exceedance of voltage in V [180...300]	240
Hysteresis in %	10
Behavior at exceeding	send nothing
Behavior at not exceeding	send OFF-telegram
Send cyclic	no send
Retention time by exceedance in sec.	0
Monitoring lower deviation of voltage	not activ

Figure 20: Menu voltage measurement

The following table shows the available settings:

ETS-text	Dynamic range [default value]	comment
General Settings		
Send value at changes	no send, 5%-75% [no send]	defines the sending behavior of the measured voltage
Send cyclic	no send, 5min-24h [no send]	defines the sending behavior of the measured voltage

Settings for voltage monitoring(adjustable for exceeding and underflow):		
Value for exceedance/lower deviation of load	180-300	defines the threshold for triggering an action for exceedance/deviating
Hysteresis in %	10-100% [10%]	defines the hysteresis
Behavior at exceeding/deviating	<ul style="list-style-type: none"> ▪ send nothing ▪ send ON-telegram ▪ send OFF-telegram 	defines the action for exceedance/deviating of the set threshold: Send ON/OFF telegram: The object sends the adjusted telegram.
Behavior at not exceeding/deviating	<ul style="list-style-type: none"> ▪ send nothing ▪ send ON-telegram ▪ send OFF-telegram 	defines the action for exceedance/deviating of the adjusted threshold; description see before
Send cyclic	no send, 5min-24h [no send]	The telegram for exceedance/deviating is sent cyclic
Retention time by exceedance/deviating in sec.	0-30000 [0]	defines a retention time, which must run out at an exceedance/deviating before a telegram is sent

Table 24: Menu voltage measurement

The behavior of the hysteresis and the retention time is described in detail in 5.1 Active power measurement.

The following table shows the available communication objects:

Number	Name	Length	Usage
9	Voltage value	2 Byte/ 4 Byte	Sending the measured voltage value
15	Exceedance of voltage	1 Bit	Sending an exceedance of voltage
16	Lower deviation of voltage	1 Bit	Sending a deviation of voltage

Table 25: Communication objects voltage measurement

5.4 Meter

The following figure shows the menu meter:

Enable main and Intermediate meter	Yes
Intermediate meter	
Object setting	Value in Wh (DPT 13.010)
Send actual count at changes	not active
Send meter reading cyclic	no send
Send actual cost at changes	active
Send actual coast all ...€	255
	€
Send actual cost cyclic	no send
Main meter	
Send actual count at changes	not active
Send meter reading cyclic	5 min
Send actual cost at changes	not active
Send actual cost cyclic	no send
Activate Event A with	not active
Activate Event B with	not active

Figure 21; Menu Meter

The following table shows the available settings:

ETS-text	Dynamic range [default value]	comment
Object setting for intermediate meter	<ul style="list-style-type: none"> ▪ Value in Wh(DPT13.010) ▪ Value in kWh(DPT13.013) 	defines if the intermediate meter is counted in watt hours or kilo watt hours
Send main meter reading cyclic	no send, 5min-24h [no send]	defines the sending behavior of the main meter
Send intermediate meter reading cyclic	no send, 5min-24h [no send]	defines the sending behavior of the intermediate meter
Send actual cost at changes	<ul style="list-style-type: none"> ▪ not active ▪ active 	Setting if the actual cost is sent at changes
Send actual cost all ...€	1-255€ [10€]	Sending interval for sending at changes
Send actual cost cyclic	no send, 5min-24h [no send]	Cyclic sending of the costs

Table 26: Menu meter

The switch actuator with active power measurement offers two meter for counting the electrical power, intermediate and main meter. The intermediate meter can count as well watt hours as kilo watt hours and can be used for shorter counting periods.

Additional the costs of each meter can be calculated. The current electrical tariff must be set in the menu Central functions -> Settings for cost calculation, described in 6.2 .

Furthermore counting periods for day and night are available. So, differentiated costs can be calculated. Also the method for day/night switchover can be set in the menu Central functions -> Settings for cost calculation, described in 6.2 .

The following table shows the available communication objects:

Number	Name	Length	Usage
17	Intermediate meter - Active Energy Wh/kwh	4 Byte	Current value of intermediate meter
18	Intermediate meter - Display costs in Euro	4 Byte	Current cost value of intermediate meter
19	Intermediate meter - Meter reading for day	4 Byte	Current value of intermediate meter in day mode
20	Intermediate meter - Meter reading for night	4 Byte	Current value of intermediate meter in night mode
21	Intermediate meter - Reset	1 Bit	Resetting the intermediate meter
22	Main meter - Active Energy Wh/kwh	4 Byte	Current value of main meter
23	Main meter - Display costs in Euro	4 Byte	Current cost value of main meter
24	Main meter - Meter reading for day	4 Byte	Current value of main meter in day mode
25	Main meter - Meter reading for night	4 Byte	Current value of main meter in night mode
26	Main meter - Reset	1 Bit	Resetting the main meter

Table 27: Communication objects total meter

5.4.1 Events

Two events can be set, which are released when the meter reaches an adjusted value:

Activate Event A with	final value at main meter
Final value	200 kWh
With object "Event A"	send OFF-telegram
All values of main meter	no send
Reset of main meter	not active

Figure 22: Events for meter

The following table shows the available settings:

ETS-text	Dynamic range [default value]	comment
Activate Event A with	<ul style="list-style-type: none"> ▪ not active ▪ final value at intermediate meter ▪ final value at main meter ▪ final value of costs at intermediate meter ▪ final value of costs at main meter ▪ time ▪ period 	Adjustment how an event is released: Final value at intermediate/main meter: Event is released at a certain value. Final value of costs at intermediate/main meter: Event is released at a certain cost value. Time: Event is released cyclic at a certain time. Period: Event is released after a certain period of time.
With object „Event A“	<ul style="list-style-type: none"> ▪ send OFF-telegram ▪ send ON-telegram 	Adjustment which value is sent at the event
All values of main/intermediate meter	<ul style="list-style-type: none"> ▪ no send ▪ send 	Adjustment if the current value of the meter is sent at the event
Reset of main/intermediate meter	<ul style="list-style-type: none"> ▪ not active ▪ active 	Adjustment if the meter is reset at the event

Table 28: Events for energy meter

The following table shows the available communication objects:

Number	Name	Length	Usage
27	Event A	1 Bit	Sending Event A
28	Event B	1 Bit	Sending Event B

Table 29: Communication objects - events for energy meter

5.5 Operating hours

The operating hours counter can count the activity of a channel. There is as well a reverse counter to the next service as a forward counter, with the setting operating hours counter, available.

5.5.1 Operating hours counter

The following illustration shows the available settings for the operating hours counter:

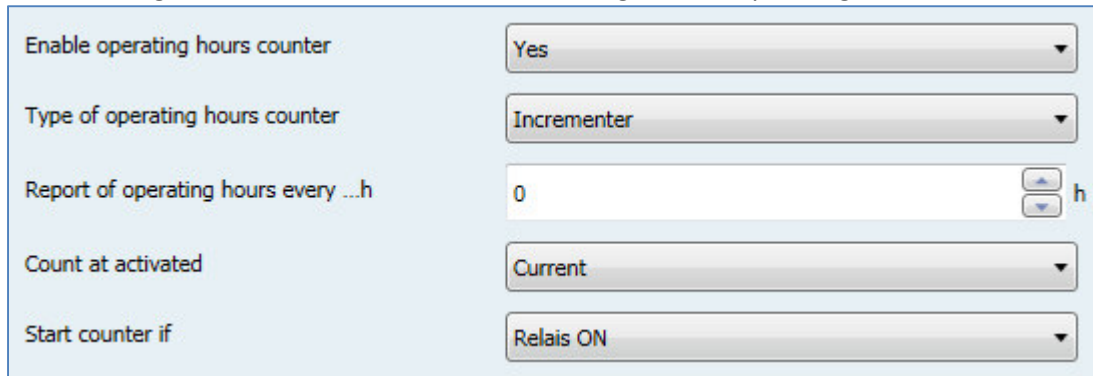

Figure 23: Operating hours counter

The following chart shows the dynamic range for this parameter:

ETS-text	Dynamic range [default value]	comment
Type of operating hours counter	Operating hours counter	Chosen operating mode: Operating hours counter
Count at activated	<ul style="list-style-type: none"> ▪ Current ▪ Power 	Setting of the threshold type for sending
Count if	<ul style="list-style-type: none"> ▪ Relay ON ▪ Current>20mA/ Power>20mW ▪ Current >50mA/ Power>50mW ▪ Current >100mA/ Power>100mW ▪ Current >200mA/ Power>200mW ▪ Current >500mA/ Power>500mW ▪ Current >1A/ Power>1W ▪ Current >2A/ Power>2W ▪ Current >5A/ Power>5W 	Adjustment of the counting condition
Send status of operating hours every ... hours	0-100 [0h]	Adjustment when a message shall be sent

Table 30: Operating hours counter

The operating hours counter can count the operating hours at which the channel is active. These can be counted as well when the channel is switched on as when a determined current value is exceeded. Furthermore can be adjusted when the communication object "Response operating hours" shall send a value. This function can be deactivated by the setting 0h. So the object is switched passive and sends no value, but can be requested. Via the object "Reset operating hours" the operating hours are set back to 0h.

The following chart shows the relevant communication objects for this parameter:

Number	Name	Length	Usage
29	Response operating hours	2 Byte	sends the number of counted operating hours
30	Reset operating hours	1 Bit	sets the operating hours back to 0h

Table 31: Communication object operating hours counter

4.7.2 Reverse counter

The following illustration shows the settings for the reverse counter to the next service:

Enable operating hours counter	Yes
Type of operating hours counter	Reverse counter
Report of service hours every ... h	0 h
Service interval at intervals of	0 h
Count at activated	Current
Start counter if	Relais ON

Figure 24: Reverse counter to next service

The following chart shows the dynamic range of this parameter:

ETS-text	Dynamic range [default value]	comment
Type of operating hours counter	Reverse counter	Chosen operating mode: Reverse counter
Count at activated	<ul style="list-style-type: none"> ▪ Current ▪ Power 	Setting of the threshold type for sending
Count if	<ul style="list-style-type: none"> ▪ Relay ON ▪ Current >20mA/ Power >20mW ▪ Current >50mA/ Power >50mW ▪ Current >100mA/ Power >100mW ▪ Current >200mA/ Power >200mW ▪ Current >500mA/ Power >500mW ▪ Current >1A/ Power >1W ▪ Current >2A/ Power >2W ▪ Current >5A/ Power >5W 	Adjustment of the counting condition
Send status of service hours every ... [h]	0-100 [0h]	Adjustment when a message shall be sent
Send signal of service at ...x10h intervals	0-250 [0h]	Adjustment when a service is required

Table 32: Reverse counter to next service

The reverse counter to the next service can count the operating hours in which the channel is active. These can be counted back as well when the channel is switched on as when a determined current value is exceeded.

The value when a service is required can be adjusted with the setting “Send signal of service at”. When this service time runs out, the dependent communication object “Service required” sends a service requirement. The setting 0h deactivates this function and so also the one described below. Via the setting “Send status of service hours every ... h” can be adjusted in which steps the object “Time to next service” sends a message with the remaining operating hours before the next service. The setting 0h deactivates this function.

The following chart shows the relevant communication objects for this parameter:

Number	Name	Length	Usage
29	Time to the next service	2 Byte	sends the remaining time to the next service
30	Reset service	1 Bit	resets service time back to the adjusted value
31	Service required	1 Bit	reports that a service is required

Table 33: Communication object reverse counter to next service

6 Central functions & Total functions

6.1 General settings

The following figure shows the available settings:

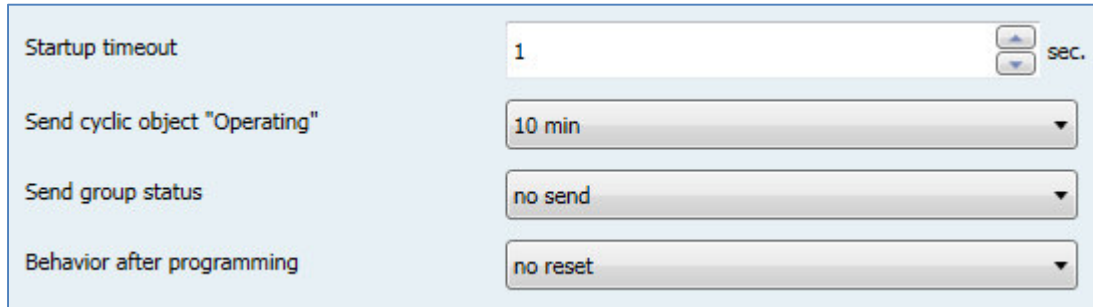

Figure 25: Menu general settings

The following table shows the available settings:

ETS-text	Dynamic range [default value]	comment
Startup timeout	0-100sec [1 sec]	Setting of the startup timeout
Send cyclic operation telegram	<ul style="list-style-type: none"> ▪ no send ▪ 10min – 24h 	Activating a cyclic operating telegram for failure detection
Send group state	<ul style="list-style-type: none"> ▪ no send ▪ on request ▪ on changes 	Activation of a group state
Behavior after programming	<ul style="list-style-type: none"> ▪ no reset ▪ reset intermediate meter ▪ reset intermediate and main meter 	Defines if the counter is reset after programming of the device

Table 34: General settings

The following table shows the available communication objects:

Number	Name	Length	Usage
132/240	Operating	1 Bit	sends cyclic „Operating“ telegram
136/244	Group state	4 Byte	sends state of all channels
135/243	Voltage error	1 Bit	sends a voltage error

Table 35: General communication objects

The object voltage error is always shown and sends an error of a channel is active with total voltage monitoring, but no voltage is applied. For adding a channel to the total voltage monitoring, the option must be enabled by the following parameter:

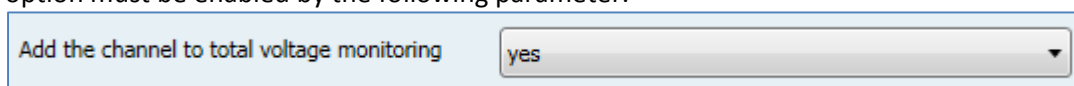

Figure 26: Adding a channel for total voltage monitoring

6.2 Settings for cost calculation

The following figure shows the menu settings for cost calculation:

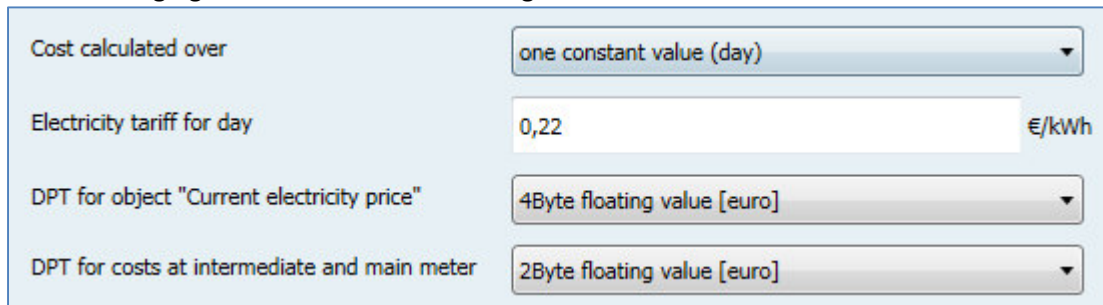

Figure 27: Menu settings for cost calculation

Costs can be calculated separately for day and night. The current electricity tariff can be set via constant or variable values. Subsequent the different methods are described:

One constant value (day):

At this setting, one constant electricity tariff is set via the parameter and is valid for day and night:

ETS-text	Dynamic range [default value]	comment
Cost calculated over	one constant value (day)	Adjustment how the costs are calculated
Electricity tariff for day	0-10€/kWh	Setting the current electricity tariff
DPT for object "Current electricity price"	<ul style="list-style-type: none"> ▪ 4 Byte Floating[Cent] ▪ 2 Byte Floating[Cent] ▪ 4 Byte Floating[Euro] ▪ 2 Byte Floating[Euro] 	Adjustment how the object "Current electricity price" is sent
DPT for costs at intermediate and main meter	<ul style="list-style-type: none"> ▪ 4 Byte Floating[Cent] ▪ 2 Byte Floating[Cent] ▪ 4 Byte Floating[Euro] ▪ 2 Byte Floating[Euro] 	Adjustment how the costs are sent at the intermediate and main meter -> valid for all channels

Table 36: Settings for cost calculation->one constant value

The following table shows the available communication objects:

Number	Name	Length	Usage
131/239	Current electricity price	2/4 Byte	Sending the current electricity price

Table 37: Communication objects for cost calculation->one constant value

Two constant values:

At this setting, two constant values for day and night are set by the parameter. It can be set as the day/night switchover takes place:

ETS-text	Dynamic range [default value]	comment
Cost calculated over	two constant values (day/night)	Adjustment how the costs are calculated
Electricity tariff for day	0-10€/kWh	Setting the current electricity tariff for day
Electricity tariff for night	0-10€/kWh	Setting the current electricity tariff for night
DPT for object “Current electricity price”	<ul style="list-style-type: none"> ▪ 4 Byte Floating[Cent] ▪ 2 Byte Floating[Cent] ▪ 4 Byte Floating[Euro] ▪ 2 Byte Floating[Euro] 	Adjustment how the object “Current electricity price” is sent
Control change day<->night over	<ul style="list-style-type: none"> ▪ Day/Night-object (Day=1/Night=0) ▪ Day/Night-object (Day=0/Night=1) ▪ Time 	Adjustment how the switchover between day/night takes place, at the setting via time, two times can be set for switching into day- and into night-mode
DPT for costs at intermediate and main meter	<ul style="list-style-type: none"> ▪ 4 Byte Floating[Cent] ▪ 2 Byte Floating[Cent] ▪ 4 Byte Floating[Euro] ▪ 2 Byte Floating[Euro] 	Adjustment how the costs are sent at the intermediate and main meter -> valid for all channels

Table 38: Settings for cost calculation->two constant values

The following table shows the available communication objects:

Number	Name	Length	Usage
131/239	Current electricity price	2/4 Byte	Sending the current electricity price
132/242	Slave time	4 Byte	Receiving the time for day/night switchover at day/night switchover by time
133/241	Day/night	1 Bit	Receiving a day/night command for the day/night switchover at day/night switchover by day/night object

Table 39: Communication objects for cost calculation->two constant values

One variable value:

At this setting, the current electricity price is sent via a communication object and is valid for day and night:

ETS-text	Dynamic range [default value]	comment
Cost calculated over	one variable value (day)	Adjustment how the costs are calculated
DPT for object “Current electricity price”	<ul style="list-style-type: none"> ▪ 4 Byte Floating[Cent] ▪ 2 Byte Floating[Cent] ▪ 4 Byte Floating[Euro] ▪ 2 Byte Floating[Euro] 	Adjustment how the object “Current electricity price” is sent
DPT for costs at intermediate and main meter	<ul style="list-style-type: none"> ▪ 4 Byte Floating[Cent] ▪ 2 Byte Floating[Cent] ▪ 4 Byte Floating[Euro] ▪ 2 Byte Floating[Euro] 	Adjustment how the costs are sent at the intermediate and main meter -> valid for all channels

Table 40: Settings for cost calculation->one variable value

The following table shows the available communication objects:

Number	Name	Length	Usage
129/237	Electricity price for day	2/4 Byte	Sending a new electricity price
131/239	Current electricity price	2/4 Byte	Sending the current electricity price

Table 41: Communication objects for cost calculation->one variable value

Two variable values:

At this setting, the current electricity price is sent via two communication objects, separately for day and night:

ETS-text	Dynamic range [default value]	comment
Cost calculated over	two variable values (day/night)	Adjustment how the costs are calculated
DPT for object “Current electricity price”	<ul style="list-style-type: none"> ▪ 4 Byte Floating[Cent] ▪ 2 Byte Floating[Cent] ▪ 4 Byte Floating[Euro] ▪ 2 Byte Floating[Euro] 	Adjustment how the object “Current electricity price” is sent
Control change day<->night over	<ul style="list-style-type: none"> ▪ Day/Night-object (Day=1/Night=0) ▪ Day/Night-object (Day=0/Night=1) ▪ Time 	Adjustment how the switchover between day/night takes place, at the setting via time, two times can be set for switching into day- and into night-mode
DPT for costs at intermediate and main meter	<ul style="list-style-type: none"> ▪ 4 Byte Floating[Cent] ▪ 2 Byte Floating[Cent] ▪ 4 Byte Floating[Euro] ▪ 2 Byte Floating[Euro] 	Adjustment how the costs are sent at the intermediate and main meter -> valid for all channels

Table 42: Settings for cost calculation->two variable values

The following table shows the available communication objects:

Number	Name	Length	Usage
129/237	Electricity price for day	2/4 Byte	Sending a new electricity price for day
130/238	Electricity price for night	2/4 Byte	Sending a new electricity price for night
131/239	Current electricity price	2/4 Byte	Sending the current electricity price
132/242	Slave time	4 Byte	Receiving the time for day/night switchover at day/night switchover by time
133/241	Day/night	1 Bit	Receiving a day/night command for the day/night switchover at day/night switchover by day/night object

Table 43: Communication objects for cost calculation->two variable values

6.3 Total active power

The following figure shows the menu for the total active power:

Enable total active power	Yes
Object setting	4Byte floating value in W (DPT 14.056)
Send value at change	7%
Send value cyclic	no send
<hr/>	
Monitoring exceeding of load	active
Value for exceeding of load in W [0...3680]	100
Hysteresis in %	10
Behavior at exceeding	send nothing
Behavior at not exceeding	send OFF-telegram
Send cyclic	no send
Retention time by exceeding in sec.	0
<hr/>	
Monitoring falling below of load	not active

Figure 28: Menu total active power

The following table shows the available settings:

ETS-text	Dynamic range [default value]	comment
General Settings		
Object selection	<ul style="list-style-type: none"> ▪ 4 Byte floating value in W (DPT14.056) ▪ 2 Byte floating value in kW (DPT9.024) 	defines the communication object of the measured active power
Send value at changes	no send, 5%-75% [no send]	defines the sending behavior of the measured active power
Send cyclic	no send, 5min-24h [no send]	defines the sending behavior of the measured active power
Settings for load monitoring(adjustable for exceeding and underflow):		
Value for exceedance/lower deviation of load	0 - 3680	defines the threshold for triggering an action for exceedance/deviating
Hysteresis in %	10-100% [10%]	defines the hysteresis
Behavior at exceeding/deviating	<ul style="list-style-type: none"> ▪ send nothing ▪ send ON-telegram ▪ send OFF-telegram ▪ send ON-telegram and channel OFF ▪ send OFF-telegram and channel OFF 	defines the action for exceedance/deviating of the set threshold: Send ON/OFF telegram: The object sends the adjusted telegram. Send ON/OFF telegram and channel OFF: The object sends the adjusted telegram and the channel is switched off
Behavior at not exceeding/deviating	<ul style="list-style-type: none"> ▪ send nothing ▪ send ON-telegram ▪ send OFF-telegram ▪ send ON-telegram and channel OFF ▪ send OFF-telegram and channel OFF 	defines the action for exceedance/deviating of the adjusted threshold; description see before
Send cyclic	no send, 5min-24h [no send]	The telegram for exceedance/deviating is sent cyclic
Retention time by exceedance/deviating in sec.	0-30000 [0]	defines a retention time, which must run out at an exceedance/deviating before a telegram is sent

Table 44: Menu total active power

The active power measurement possible by simultaneous measurement of current and voltage output of the real active power. So the returned value is no longer a "theoretical" power at rated voltage, but the real power.

For the active power measurement, a monitoring of the load can be enabled and triggering specific actions. At the exceedance of load, the **hysteresis** causes a shift of the cut-off threshold. So, a hysteresis of 10% and a value for load exceeding of 100W causes a value for exceedance of 100W, which is only turned off when the measured value falls below 90W. In the underrun, a hysteresis of 10% and a value for underrun of 100W causes an active lower deviation of load at 100W, which is released until the value exceeds 110W again.

The **retention time by exceedance/deviating** specifies how long an exceedance/deviation must be measured for the output before the action for exceedance/deviation is triggered. So a retention time by exceedance of 10s causes that an exceedance must be measured for 10s before the action for exceedance is triggered. The retention time works with the hysteresis output. Thus, if an exceedance is measured, the power must fall below the hysteresis value for stopping the retention time timer.

For adding a channel to the evaluation of the total active power, this setting must be enabled for the channel:

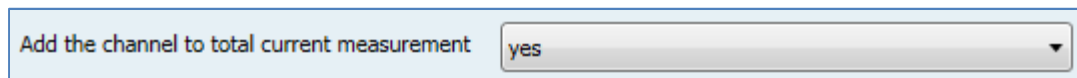

Figure 29: Add channel to evaluation of total active power

The following table shows the available communication objects:

Number	Name	Length	Usage
110/218	Total active power – Total value	2 Byte/ 4 Byte	Sending the total active power
113/221	Total active power – Exceedance of Load	1 Bit	Sending an exceedance of a certain load
114/222	Total active power – Falling below of Load	1 Bit	Sending falling below a certain load

Table 45: Communication objects - total active power

6.4 Total current

The following figure shows the menu for the total active power:

Enable total current	Yes
Object setting	Value in mA (DPT 7.012)
Send value at change	no send
Retention time by exceeding in sec.	no send
<hr/>	
Monitoring exceeding of current	active
Value for exceeding of current in mA [3...16000]	100
Hysteresis in %	10
Behavior at exceeding	send nothing
Behavior at not exceeding	send nothing
Send cyclic	no send
Retention time by exceeding in sec.	0
<hr/>	
Monitoring falling below of current	not active

Figure 30: Menu total current

The following table shows the available settings:

ETS-text	Dynamic range [default value]	comment
General Settings		
Object selection	<ul style="list-style-type: none"> ▪ Value in mA (DPT7.012) ▪ Floating value in mA (DPT9.021) ▪ Floating value in A (DPT14.019) 	defines the communication object of the measured current
Send value at changes	no send, 5%-75% [no send]	defines the sending behavior of the measured current
Send cyclic	no send, 5min-24h [no send]	defines the sending behavior of the measured current
Settings for current monitoring(adjustable for exceeding and underflow):		
Value for exceedance/lower deviation of load	0 - 16000	defines the threshold for triggering an action for exceedance/deviating
Hysteresis in %	10-100% [10%]	defines the hysteresis
Behavior at exceeding/deviating	<ul style="list-style-type: none"> ▪ send nothing ▪ send ON-telegram ▪ send OFF-telegram ▪ send ON-telegram and channel OFF ▪ send OFF-telegram and channel OFF 	defines the action for exceedance/deviating of the set threshold: Send ON/OFF telegram: The object sends the adjusted telegram. Send ON/OFF telegram and channel OFF: The object sends the adjusted telegram and the channel is switched off
Behavior at not exceeding/deviating	<ul style="list-style-type: none"> ▪ send nothing ▪ send ON-telegram ▪ send OFF-telegram ▪ send ON-telegram and channel OFF ▪ send OFF-telegram and channel OFF 	defines the action for exceedance/deviating of the adjusted threshold; description see before
Send cyclic	no send, 5min-24h [no send]	The telegram for exceedance/deviating is sent cyclic
Retention time by exceedance/deviating in sec.	0-30000 [0]	defines a retention time, which must run out at an exceedance/deviating before a telegram is sent

Table 46: Menu current measurement

The behavior of the hysteresis and the retention time is described in 6.3 .

For adding a channel to the evaluation of the total current, this setting must be enabled for the channel:

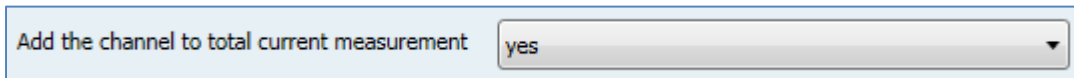

Figure 31: Add channel to evaluation of total current

The following table shows the available communication objects:

Number	Name	Length	Usage
111/219	Total current – Total value	2 Byte/ 4 Byte	Sending the total current
115/223	Total current – Exceedance of current	1 Bit	Sending an exceeding of an adjusted current
116/224	Total current – Lower deviation of current	1 Bit	Sending falling below an adjusted current

Table 47: Communication objects total current

6.5 Total energy meter and cost counter

The following figure shows the menu total energy meter and cost counter:

Enable total energy meter and cost counter	Yes
Intermediate meter	
Object setting	Value in Wh (DPT 13.010)
Send actual count at changes	not active
Send meter reading cyclic	no send
Send actual cost at changes	not active
Send actual cost cyclic	no send
Main meter	
Send actual count at changes	not active
Send meter reading cyclic	5 min
Send actual cost at changes	not active
Send actual cost cyclic	no send
Activate Event A with	not active
Activate Event B with	not active

Figure 32: Menu total energy meter and cost counter

For adding a channel to the evaluation of the total current, this setting must be enabled for the channel:

Add the channel to total current measurement	yes
--	-----

Figure 33: Add channel to evaluation of total energy meter and cost counter

The following table shows the available settings:

ETS-text	Dynamic range [default value]	comment
Object setting for intermediate meter	<ul style="list-style-type: none"> ▪ Value in Wh(DPT13.010) ▪ Value in kWh(DPT13.013) 	defines if the intermediate meter is counted in watt hours or kilo watt hours
Send main meter reading cyclic	no send, 5min-24h [no send]	defines the sending behavior of the main meter
Send intermediate meter reading cyclic	no send, 5min-24h [no send]	defines the sending behavior of the intermediate meter
Send actual cost at changes	<ul style="list-style-type: none"> ▪ not active ▪ active 	Setting if the actual cost is sent at changes
Send actual cost all ...€	1-255€ [10€]	Sending interval for sending at changes
Send actual cost cyclic	no send, 5min-24h [no send]	Cyclic sending of the costs

Table 48: Menu total energy meter and cost counter

The switch actuator with active power measurement offers two meter for counting the electrical power, intermediate and main meter. The intermediate meter can count as well watt hours as kilo watt hours and can be used for shorter counting periods.

Additional the costs of each meter can be calculated. The current electrical tariff must be set in the menu Central functions -> Settings for cost calculation, described in 6.2 .

Furthermore counting periods for day and night are available. So, differentiated costs can be calculated. Also the method for day/night switchover can be set in the menu Central functions -> Settings for cost calculation, described in 6.2 .

The following table shows the available communication objects:

Number	Name	Length	Usage
117/225	Total intermediate meter - Active Energy Wh/kwh	4 Byte	Current value of intermediate meter
118/226	Total intermediate meter - Display costs in Euro	4 Byte	Current cost value of intermediate meter
119/227	Total intermediate meter - Meter reading for day	4 Byte	Current value of intermediate meter in day mode
120/228	Total intermediate meter - Meter reading for night	4 Byte	Current value of intermediate meter in night mode
121/229	Total intermediate meter - Reset	1 Bit	Resetting the intermediate meter
122/230	Total main meter - Active Energy Wh/kwh	4 Byte	Current value of main meter
123/231	Total main meter - Display costs in Euro	4 Byte	Current cost value of main meter
124/232	Total main meter - Meter reading for day	4 Byte	Current value of main meter in day mode
125/233	Total main meter - Meter reading for night	4 Byte	Current value of main meter in night mode
126/234	Total main meter - Reset	1 Bit	Resetting the main meter

Table 49: Communication objects total energy meter and cost counter

6.5.1 Events

Two events can be set, which are released when the meter reaches an adjusted value:

Activate Event A with	final value at main meter
Final value	200 kWh
With object "Event A"	send OFF-telegram
All values of main meter	no send
Reset of main meter	not active

Figure 34: Events for meter

The following table shows the available settings:

ETS-text	Dynamic range [default value]	comment
Activate Event A with	<ul style="list-style-type: none"> ▪ not active ▪ final value at intermediate meter ▪ final value at main meter ▪ final value of costs at intermediate meter ▪ final value of costs at main meter ▪ time ▪ period 	Adjustment how an event is released: Final value at intermediate/main meter: Event is released at a certain value. Final value of costs at intermediate/main meter: Event is released at a certain cost value. Time: Event is released cyclic at a certain time. Period: Event is released after a certain period of time.
With object „Event A“	<ul style="list-style-type: none"> ▪ send OFF-telegram ▪ send ON-telegram 	Adjustment which value is sent at the event
All values of main/intermediate meter	<ul style="list-style-type: none"> ▪ no send ▪ send 	Adjustment if the current value of the meter is sent at the event
Reset of main/intermediate meter	<ul style="list-style-type: none"> ▪ not active ▪ active 	Adjustment if the meter is reset at the event

Table 50: Events for energy meter

The following table shows the available communication objects:

Number	Name	Length	Usage
127/235	Event A	1 Bit	Sending Event A
128/236	Event B	1 Bit	Sending Event B

Table 51: Communication objects for events of total active power meter and cost counter

7 Index

7.1 List of figures

Figure 1: Overview Hardware.....	5
Figure 2: Operating mode	20
Figure 3: Central function.....	21
Figure 4: Blocking function.....	21
Figure 5: Switching output	23
Figure 6: On/Off delay	25
Figure 7: Logical functions.....	26
Figure 8: Overview Logic function	26
Figure 9: Scene function.....	28
Figure 10: Sub function scene	29
Figure 11: Programming of scenes.....	32
Figure 12: Staircase	33
Figure 13: Staircase time	35
Figure 14: Warning timer & prewarning time	36
Figure 15: Manual switch off.....	37
Figure 16: Extend staircase time	37
Figure 17: Menu "Active power measurement"	38
Figure 18: Advanced power output.....	41
Figure 19: Menu current measurement.....	42
Figure 20: Menu voltage measurement.....	44
Figure 21; Menu Meter	46
Figure 22: Events for meter.....	48
Figure 23: Operating hours counter.....	49
Figure 24: Reverse counter to next service.....	50
Figure 25: Menu general settings.....	52
Figure 26: Adding a channel for total voltage monitoring	52
Figure 27: Menu settings for cost calculation	53
Figure 28: Menu total active power.....	57
Figure 29: Add channel to evaluation of total active power.....	59
Figure 30: Menu total current.....	60
Figure 31: Add channel to evaluation of total current.....	62
Figure 32: Menu total energy meter and cost counter.....	63
Figure 33: Add channel to evaluation of total energy meter and cost counter.....	63
Figure 34: Events for meter.....	65

7.2 List of tables

Table 1: Communication objects switching output.....	9
Table 2: Overview objects – Measurement	13
Table 3: Overview Communication objects - central functions	16
Table 4: Communication objects – default settings.....	19
Table 5: Operating mode.....	20
Table 6: Central function.....	21
Table 7: Communication object central function.....	21
Table 8: Behavior at block/unblock.....	21
Table 9: Communication object blocking function.....	22
Table 10: Switching output.....	24
Table 11: Communication objects logic	26
Table 12: Logic function	27
Table 13: Communication object scene	28
Table 14: Parameter scene.....	30
Table 15: Calling and saving scenes.....	31
Table 16: Parameter staircase	34
Table 17: Communication object staircase	35
Table 18: Menu "Active power measurement"	39
Table 19: Communication objects power measurement.....	40
Table 20: Advanced power output.....	41
Table 21: Communication objects advanced power measurement	41
Table 22: Menu current measurement	43
Table 23: Communication objects current measurement	43
Table 24: Menu voltage measurement	45
Table 25: Communication objects voltage measurement	45
Table 26: Menu meter.....	47
Table 27: Communication objects total meter.....	47
Table 28: Events for energy meter	48
Table 29: Communication objects - events for energy meter.....	48
Table 30: Operating hours counter	49
Table 31: Communication object operating hours counter	49
Table 32: Reverse counter to next service	50
Table 33: Communication object reverse counter to next service	51
Table 34: General settings.....	52
Table 35: General communication objects.....	52
Table 36: Settings for cost calculation->one constant value.....	53
Table 37: Communication objects for cost calculation->one constant value	53
Table 38: Settings for cost calculation->two constant values.....	54
Table 39: Communication objects for cost calculation->two constant values	54
Table 40: Settings for cost calculation->one variable value.....	55
Table 41: Communication objects for cost calculation->one variable value	55
Table 42: Settings for cost calculation->two variable values	56
Table 43: Communication objects for cost calculation->two variable values.....	56
Table 44: Menu total active power	58
Table 45: Communication objects - total active power	59
Table 46: Menu current measurement	61
Table 47: Communication objects total current	62
Table 48: Menu total energy meter and cost counter	64
Table 49: Communication objects total energy meter and cost counter	64
Table 50: Events for energy meter	65
Table 51: Communication objects for events of total active power meter and cost counter	65

8 Attachment

8.1 Statutory requirements

The above-described devices must not be used with devices, which serve directly or indirectly the purpose of human, health- or lifesaving. Further the devices must not be used if their usage can occur danger for humans, animals or material assets.

Do not let the packaging lying around careless, plastic foil/ -bags etc. can be a dangerous toy for kids.

8.2 Routine disposal

Do not throw the waste equipment in the household rubbish. The device contains electrical devices, which must be disposed as electronic scrap. The casing contains of recyclable synthetic material.

8.3 Assemblage



Risk for life of electrical power!

All activities on the device should only be done by an electrical specialist. The county specific regulations and the applicable EIB-directives have to be observed.

8.4 Datasheet

MDT Switch Actuator 3/6-fold with current/active power measurement, MDRC

Version		
AZI-0316.01	Switch Actuator 3-fold	4SU MDRC, 230VAC, 16/20A, C-Load 240uF, current/active power measurement
AZI-0616.01	Switch Actuator 6-fold	8SU MDRC, 230VAC, 16/20A, C-Load 200uF, current/active power measurement

The MDT Switch Actuator receives KNX/EIB telegrams and switches up to 6 independent electrical loads. Each output uses a bistable relay and can be operated manually via a push button. A green LED indicates the switching status of each channel.

The outputs are parameterized individually via ETS3/4. The device provides extensive functions like logical operation, status response, block functions, central function, delay functions and staircase lighting function. Additionally the device provides several time and scene control.

The MDT Switch Actuator offers current measurement for each channel and measurement of the total current. In dependence on the parameterization the measured data can be transmit in different data formats (mA/A/kW) onto the KNX bus. Additionally the device provides an hour/service interval meter. The integrated counter allows to capture the active power consumption exactly.

If the mains voltage fails, all outputs hold their current position. After bus voltage failure or recovery the relay position is selected in dependence on the parameterization.

The MDT Switch Actuator is a modular installation device for fixed installation in dry rooms. It fits on DIN 35mm rails in power distribution boards or closed compact boxes. The MDT Switch Actuator has a separate power supply terminals for each channel.

For project design and commissioning of the MDT Switch Actuator it is recommended to use the ETS or later. Please download the application software at www.mdt.de/Downloads.html

AZI-0316.01



AZI-0616.01



- Production in Germany, certified according to ISO 9001
- Push Button and LED indicator for each channel
- NO and NC contact operation
- Time functions (switch-on/switch-off delay, staircase light function)
- Status response (active/passive) for each channel
- Logical linking of binary data, 8 scenes per channel
- Hour meter
- Central switching functions and block functions
- Adjustable behaviour in case of bus voltage failure or return
- Each contact has an own supply phase
- **Integrated True RMS current measurement (current, kW)**
- **Current measurement range 10mA-20A**
- **Fast reaction <1s at Master/Slave operation**
- **Active power measurement with integrated counter (Wh/kWh) with current and voltage rating**
- Power supply via KNX bus
- Modular installation device for DIN 35mm rails
- Integrated bus coupling unit
- 3 years warranty

Technical Data	AZI-0316.01	AZI-0616.01
Number of outputs	3	6
Current measurement range	10mA - 20A	10mA - 20A
Measuring inaccuracy	2%	2%
Sampling rate	2000 samples/500ms	2000 samples/500ms
Output switching ratings		
Ohmic load	16/20A*	16/20A*
Capacitive load	200uF at 16A	200uF at 16A
Voltage	230VAC	230VAC
Maximum inrush current	600A/150µs 300A/600µs	600A/150µs 300A/600µs
Maximum load		
Incandescent lamps	3680W	3680W
Halogen lamps 230V	3680W	3680W
Halogen lamps, electronic transformer**	2000W	2000W
Fluorescent lamps, not compensated	3680W	3680W
Fluorescent lamps, parallel comp.	2500W	2500W
Max. number of electronic transformers	28	28
Output life expectancy (mechanical)	1.000.000	1.000.000
Specification KNX interface	TP-256	TP-256
Available application software	ETS 4/5	ETS 4/5
Permitted wire gauge		
Screw terminal	1 x 0,5 - 4,0mm ² solid core / finely stranded 2 x 0,5 - 2,5mm ² solid core / finely stranded (no mix allowed)	
KNX busconnection terminal	0,8mm Ø, solid core	0,8mm Ø, solid core
Torque screw terminal	0,5Nm	0,5Nm
Power supply	KNX bus	KNX bus
Power consumption KNX bus typ.	< 0,4W	< 0,4W
Operation temperature range	0 to + 45°C	0 to + 45°C
Enclosure	IP 20	IP 20
Dimensions MDRC (Space Units)	4SU	8SU

* total current carrying capacity neighbouring outputs max. 32A

** low voltage halogen lamps with electronic transformer

Exemplary circuit diagram AZI-0316.01

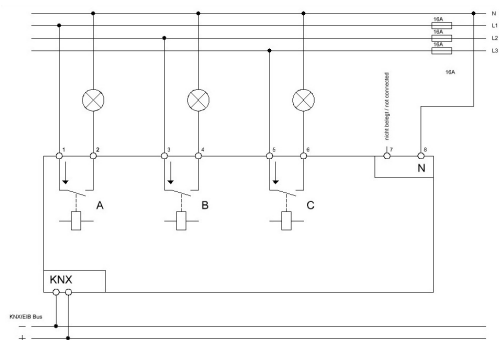

Exemplary circuit diagram AZI-0616.01

